





RS35, RS50, RS80

relays for solar inverters and high current applications





- **Relays to control power in photovoltaic systems which generate electric energy** • Max. switching current: 35 A (RS35); 50 A (RS50); 80 A (RS80) • 5000 V / 10 mm reinforced insulation
- Contact gap: $\geq 2,2$ mm (RS35); $\geq 1,8$ mm (RS50); $\geq 4,1$ mm (RS80)
- Holding power 0,1 W • For PCB
- DC coils, insulation class F: 155 °C • Reinforced insulation, acc. EN 60730-1 (VDE 0631, part 1); EN 60335-1 (VDE 0700, part 1)
- Recognitions, certifications, directives: RoHS,     

Contact data

Number and type of contacts		RS35: 2 NO	RS50: 1 NO, 2 NO	RS80: 1 NO (double-break)
Contact material		AgSnO₂		
Rated / max. switching voltage	AC	250 V / 440 V		
Min. switching voltage		10 V		
Rated load				
	AC1	RS35: 35 A / 250 V AC	RS50: 50 A / 250 V AC	RS80: 80 A / 250 V AC 90 A / 230 V AC
	DC1	35 A / 24 V DC	50 A / 24 V DC	80 A / 24 V DC
Min. switching current		10 mA	10 mA	10 mA
Rated current		35 A	50 A	80 A
Max. breaking capacity				
	AC1	8 750 VA	12 500 VA	20 000 VA
	DC1	90 W 0,3 A / 300 V	90 W 0,3 A / 300 V	90 W 0,3 A / 300 V
Min. breaking capacity		1 W		
Contact resistance		≤ 50 m Ω		
Max. operating frequency		360 cycles/hour		
	• at rated load AC1 • no load	3 600 cycles/hour		



Coil data



Rated voltage	DC	RS35, RS50: 5, 9, 12, 18, 24, 110 V	RS80: 12, 24 V 
Must release voltage		DC: $\geq 0,05 U_n$	
Operating range of supply voltage		0,75...2,0 U _n  see Table 1	
Rated power consumption	DC	0,48 W	
Power consumption at pickup voltage		0,27 W	

Insulation according to EN 60664-1

Insulation rated voltage		250 V AC	
Overvoltage category		III	
Insulation pollution degree		3	
Insulation resistance		1000 M Ω	
Dielectric strength			
	• between coil and contacts	5 000 V AC	type of insulation: reinforced
	• contact clearance	2 500 V AC	type of clearance: full-disconnection
	• pole - pole	2 500 V AC	type of insulation: basic
Contact - coil distance			
	• clearance	≥ 10 mm	
	• creepage	≥ 10 mm	

General data

Operating / release time (typical values)		RS35, RS50: 30 ms / 5 ms	RS80: 40 ms / 5 ms
Max. continuous dissipation		1,9 W 20 °C	
Electrical life			
	• resistive AC1	5 x 10 ⁴	RS35: 35 A, RS50: 50 A, 250 V AC, 20 °C
		6 x 10 ³	RS35: 35 A, RS50: 50 A, 277 V AC, 85 °C (UL)
		10 ³	RS80: 80 A, 277 V AC, 85 °C (UL, VDE)
		10 ³	RS80: 90 A, 230 V AC, 85 °C (BBJ )
	• AC7a	3 x 10 ⁴	RS35: 35 A, 263 V AC, 85 °C (VDE)
		1,5 x 10 ⁴	RS50: 50 A, 263 V AC, 85 °C (VDE)
		3 x 10 ⁴	RS80: 30 A, 263 V AC, 85 °C (VDE)
Mechanical life (cycles)		10 ⁶	
Dimensions (L x W x H) / Weight		40 x 25 x 49,2 mm / 105 g	
Ambient temperature			
	• storage	-40...+105 °C	
	• operating	-40...+85 °C 	
Cover protection category		IP 40	EN 60529
Environmental protection		RTII	EN 61810-7
Shock resistance		10 g	
Vibration resistance		1,5 mm DA (constant amplitude)	10...55 Hz
Solder bath temperature		max. 270 °C	
Soldering time		max. 5 s	

The data in bold type relate to the standard versions of the relays.  Rest coil voltages like for RS35, RS50 available on request (outside the scope of the certificates UL, VDE).  At 85 °C permissible max. coil supply voltage not higher than 10% over nominal coil voltage.  BBJ: Association of Polish Electrical Engineers - Quality Testing Office.

RS35, RS50, RS80

relays for solar inverters and high current applications

Dimensions

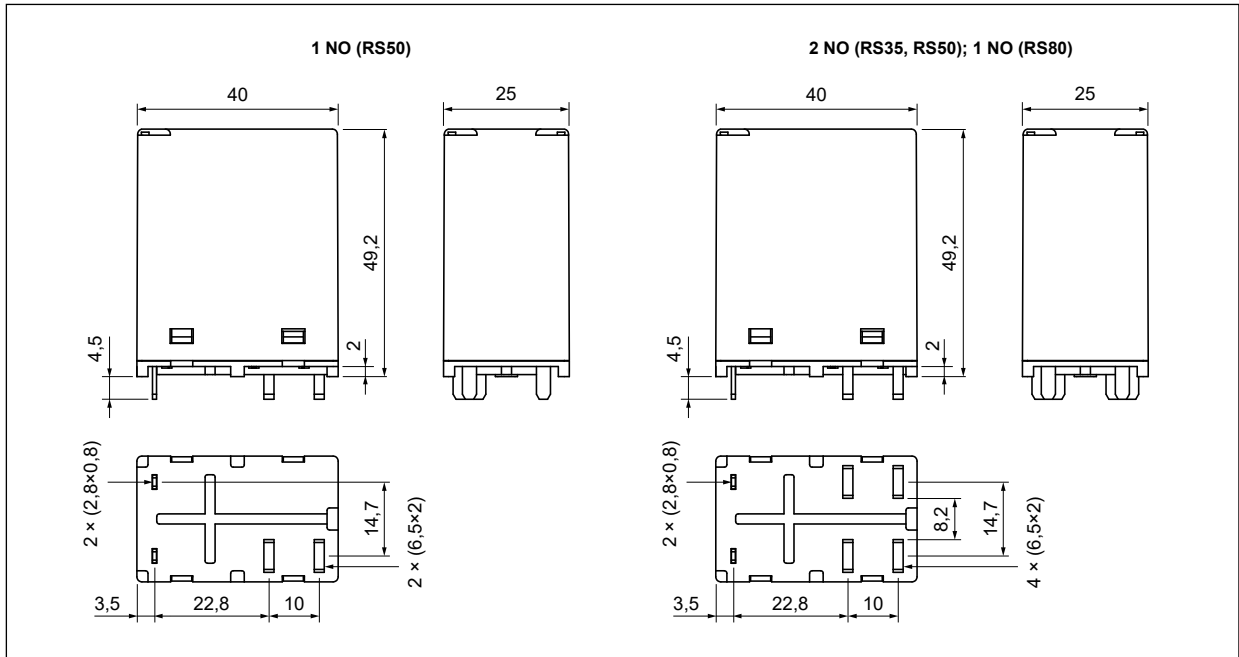

Pinout (solder side view)

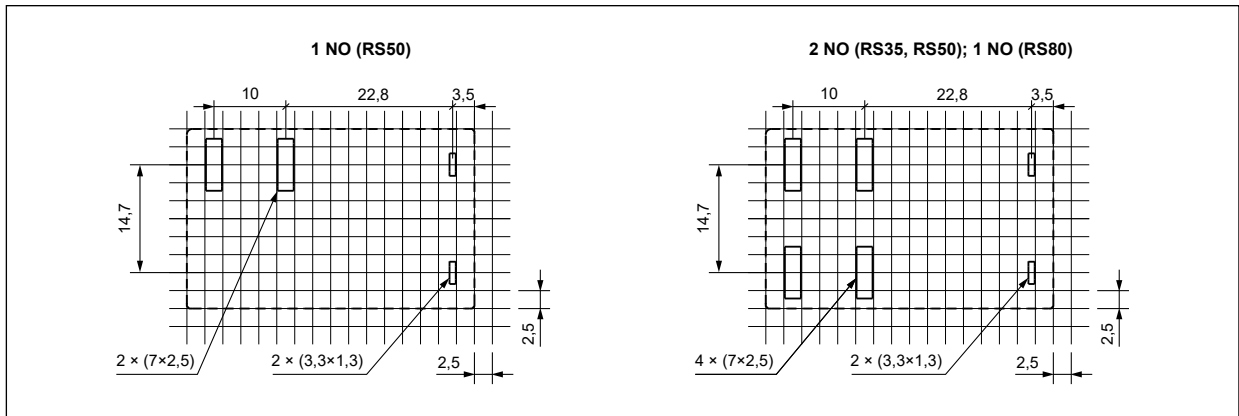

Connection diagrams (pin side view)

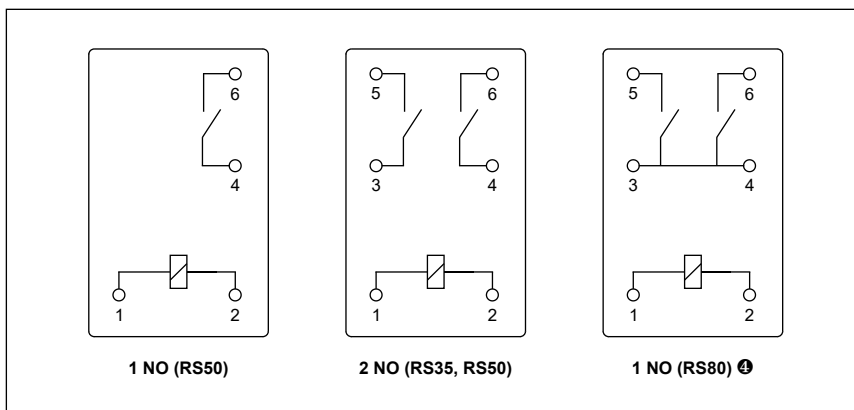

Ⓜ To ensure proper operation of the relay, it is required to use multi-layer boards and make a connection on the PCB of pins 3-4 and also of pins 5-6.



23.11.2021

RS35, RS50, RS80

relays for solar inverters and high current applications

Mounting

Relays **RS35, RS50, RS80** are designed for direct PCB mounting .

 An appropriate cross-section of the PCB must be provided in accordance with design standards, to ensure proper heat dissipation from the contact terminals under load.

Coil data - DC voltage version

Table 1

Coil code	Rated voltage V DC 	Coil resistance at 20 °C Ω	Acceptable resistance	Coil operating range V DC	
				min. (at 20 °C)	max. (at 20 °C)
1005	5	50	$\pm 10\%$	3,75	10
1009	9	170	$\pm 10\%$	6,75	18
1012	12	300	$\pm 10\%$	9,00	24
1018	18	675	$\pm 10\%$	13,50	36
1024	24	1 200	$\pm 10\%$	18,00	48
1110	110	25 000	$\pm 10\%$	82,50	220

 For RS80: only 12, 24 V DC; rest coil voltages like for RS35, RS50 available on request (outside the scope of the certificates UL, VDE).

Ordering codes

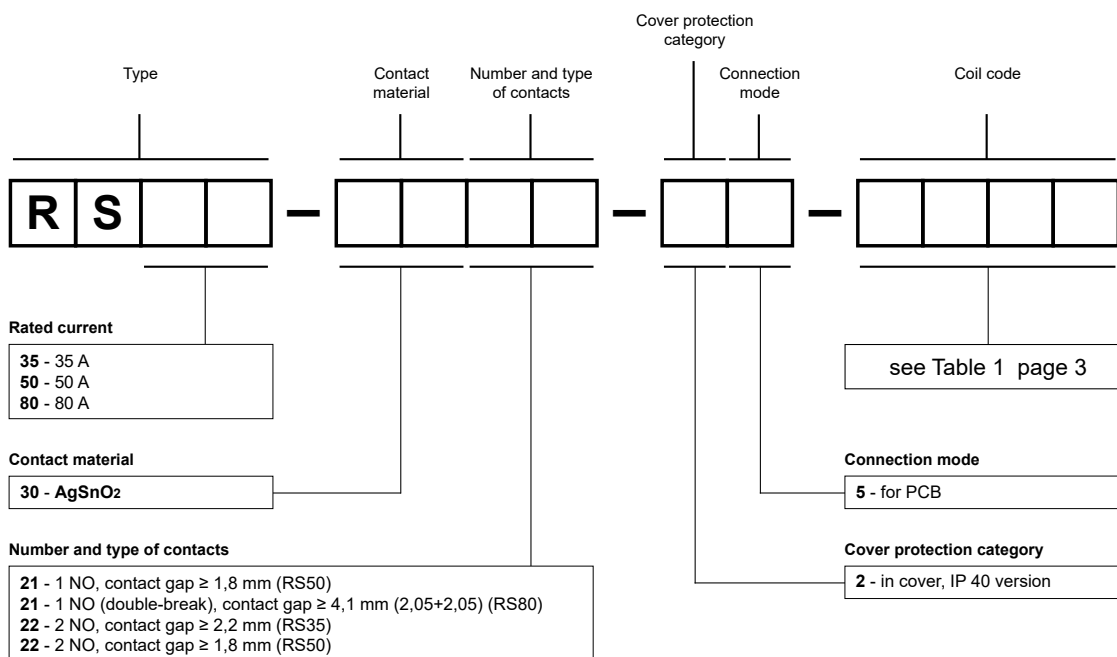

Examples of ordering code:

RS35-3022-25-1005

relay **RS35**, rated current 35 A, for PCB, two normally open contacts, with contact gap $\geq 2,2$ mm, contact material AgSnO₂, coil voltage 5 V DC, in cover IP 40

RS50-3022-25-1110

relay **RS50**, rated current 50 A, for PCB, two normally open contacts, with contact gap $\geq 1,8$ mm, contact material AgSnO₂, coil voltage 110 V DC, in cover IP 40

RS80-3021-25-1024

relay **RS80**, rated current 80 A, for PCB, one normally open contact (double-break), with contact gap $\geq 4,1$ mm (2,05+2,05), contact material AgSnO₂, coil voltage 24 V DC, in cover IP 40

PRECAUTIONS:

1. Ensure that the parameters of the product described in its specification provide a safety margin for the appropriate operation of the device or system and never use the product in circumstances which exceed the parameters of the product. 2. Never touch any live parts of the device. 3. Ensure that the product has been connected correctly. An incorrect connection may cause malfunction, excessive heating or risk of fire. 4. In case of any risk of any serious material loss or death or injuries of humans or animals, the devices or systems shall be designed so to equip them with double safety system to guarantee their reliable operation.