

PIR6WB-1PS-...

interface relays with spring terminals

RM699BV + PI6WB-1PS-... RSR30 + PI6WB-1PS-...



- Width 6,2 mm • Interface relay **PIR6WB-1PS-...** consists of: spring terminals ① universal socket, with electronic **PI6WB-1PS-...**, miniature operational relay - electromagnetic **RM699BV** or solid state **RSR30** ②
- 35 mm rail mount acc. to EN 60715 • May be linked with 20-pole interconnection strip type **ZG20** • Equipped in LED green • Version for long control lines, with anti-interference filter (**PIR6WB-1P-230V...-10** ③)
- Accessories: description plates **PI6W-1246**
- Recognitions, certifications, directives: RoHS,



Output circuit (RM699BV) - contact data ②

Number and type of contacts (code of output)	1 CO (R) ⑤	1 CO (R01) ⑤
Contact material	AgSnO₂	AgSnO ₂ /Au hard gold plating ⑤
Max. switching voltage	400 V AC / 250 V DC	30 V AC / 36 V DC ⑤
Min. switching voltage	AC / DC	10 V
Rated load	AC1	6 A / 250 V AC
	DC1	6 A / 24 V DC; 0,15 A / 250 V DC
Min. switching current		100 mA
Max. inrush current		10 A 20 ms
Rated current		6 A
Max. breaking capacity	AC1	1 500 VA
Min. breaking capacity		1 W
Contact resistance		≤ 100 mΩ 100 mA, 24 V
Max. operating frequency		≤ 30 mΩ 10 mA, 5 V
• at rated load	AC1	360 cycles/hour
• no load		72 000 cycles/hour

Output circuit (RSR30) - output data ②

Type of output (code of output)	Triac (T) ⑤ max. 2 A	Transistor (C) ⑤ max. 1 A	Transistor (O) ⑤ max. 2 A
Number and type of outputs	1 NO	1 NO	1 NO
Rated voltage	240 V AC	48 V DC	24 V DC
Switching voltage range	12 ... 280 V AC	1,5 ... 60 V DC	1,5 ... 32 V DC
Rated continuous output current	AC1	1 A	2 A
	DC1	1 A	2 A
Min. making capacity current		50 mA	1 mA
Max. off-state leakage current (turn-off state)		1,5 mA	1 mA
Max. on-state voltage drop on the connection (operating state)		1,2 V	0,4 V
Operating switching frequency		10 Hz	10 Hz

Input circuit

Rated voltage	50/60 Hz AC	230 V
	DC	6, 12, 24, 36, 48, 60 V
	AC: 50/60 Hz AC/DC	24, 42, 115, 230 V
Must release voltage		AC: ≥ 0,2 U _n AC: ≥ 0,35 U _n 230 V AC ④ DC: ≥ 0,1 U _n
Operating range of supply voltage		AC: ≥ 0,1 U _n 230 V AC AC: ≥ 0,35 U _n 230 V AC/DC ④ DC: ≥ 0,1 U _n
Must operate voltage		0,8...1,2 U _n
		0,85...1,2 U _n 6 V DC
Rated power consumption	AC	≤ 0,8 ... 0,9 VA
	DC	0,2 ... 0,5 W
	AC/DC	0,5 ... 1,2 VA / 0,4 ... 1,2 W
Max. length of control line		≤ 300 m AC control voltage ④

The data in bold type relate to the standard versions of the relays. ① Spring fixing terminals for electric wires (cage springs CAGE CLAMP® - is the registered trademark of WAGO Kontakttechnik GmbH & Co. KG, Germany). ② Characteristics of the contact capacity of relays **PIR6WB-1PS-...** with **RM699BV**, **PIR6WB-1PS-...** with **RSR30** - see www.relpol.com.pl ③ For gold-plated contacts - when the maximum values given have been exceeded, the gold layer is destroyed. Then, the advantages of gold-plating disappear and the values are as for AgSnO₂ contacts (see beside), and electrical life of these contacts may be shorter than of normal contacts. ④ Refers version for long control lines (max. 300 m) **PIR6WB-1P-230V...-10** - relay which includes the socket **PI6WB-1P-230V...-10** with integrated anti-interference filter, resistant to occurrence of induced voltages in long distances of control wires, and operational miniature relay **RM699BV-3011-85-1060**. ⑤ Type of outputs: **R** - contacts AgSnO₂; **R01** - contacts AgSnO₂/Au hard gold plating; **T** - triac; **C** - transistor; **O** - transistor.

PIR6WB-1PS-...

interface relays with spring terminals

Insulation according to EN 60664-1

Insulation rated voltage	250 V AC
Rated surge voltage	4 000 V 1,2 / 50 µs
Overvoltage category	III
Insulation pollution degree	3
Dielectric strength	<ul style="list-style-type: none"> • input - output 4 000 V AC 50/60 Hz, 1 min., type of insulation: reinforced • input - output 6 000 V 1,2 / 50 µs • mass - input, output 2 500 V AC 50/60 Hz, 1 min. • contact clearance 1 000 V AC 50/60 Hz, 1 min., output R and R01, type of clearance: micro-disconnection
Input - output distance	clearance / creepage: ≥ 6 mm / ≥ 8 mm
Mass - output distance	clearance / creepage: ≥ 3 mm / ≥ 4 mm
General data	
Operating time (typical value)	PIR6WB-1PS-...-R/-R01: DC: 8 ms AC, AC/DC: 20 ms PIR6WB-1PS-...-T: DC: 100 µs AC, AC/DC: 10 ms PIR6WB-1PS-...-C/-O: DC: 50 µs AC, AC/DC: 10 ms
Release time (typical value)	PIR6WB-1PS-...-R/-R01: DC: 10 ms AC, AC/DC: 25 ms (18 ms ④) PIR6WB-1PS-...-T: DC: 1/2 cycle + 1 ms AC, AC/DC: 30 ms PIR6WB-1PS-...-C/-O: DC: 600 µs AC, AC/DC: 20 ms
Electrical life	• resistive AC1 PIR6WB-1PS-...-R: $> 0,5 \times 10^5$ 6 A, 250 V AC
Mechanical life (cycles)	PIR6WB-1PS-...-R/-R01: $> 10^7$
Dimensions (L x W x H)	98,3 x 6,2 x 84,6 mm
Weight	55 g
Ambient temperature	<ul style="list-style-type: none"> • storage PIR6WB-1PS-...-R/-R01/-T: -40...+70 °C ...-C/-O: -25...+70 °C PIR6WB-1P-230V...-10 ④: -25...+70 °C • operating PIR6WB-1PS-...-R/-R01: -40...+55 °C ...-T/-C/-O: -25...+55 °C PIR6WB-1PS-230VAC/DC-R/-R01/-C/-O: -25...+50 °C ⑥ PIR6WB-1P-230V...-10 ④: -25...+50 °C ⑥
Cover protection category	IP 20 EN 60529
Environmental protection	RTI EN 61810-7
Shock resistance	10 g
Vibration resistance	5 g 10...500 Hz

④ Refers version for long control lines (max. 300 m), with integrated anti-interference filter.

⑥ For versions 230VAC/DC and 230VAC/DC-10: the distance at least 5 mm between the relays mounted side by side.

Dimensions

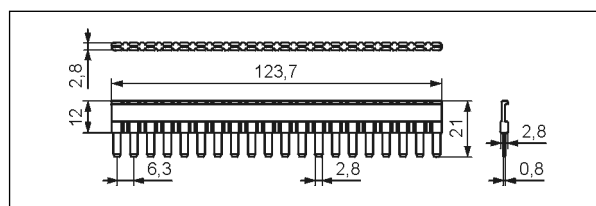
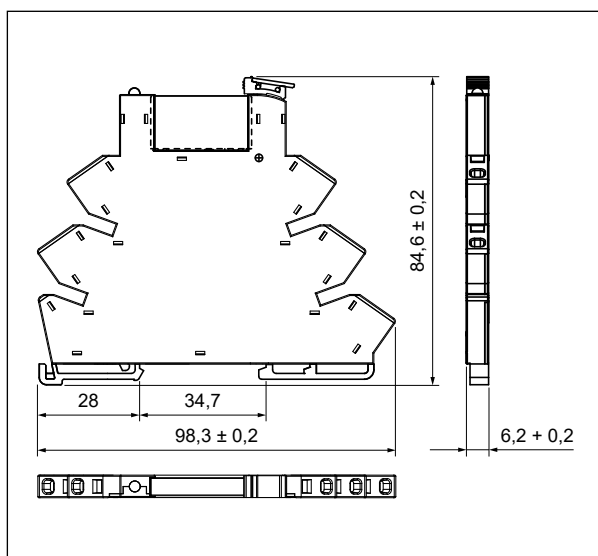

20-pole interconnection strip type ZG20

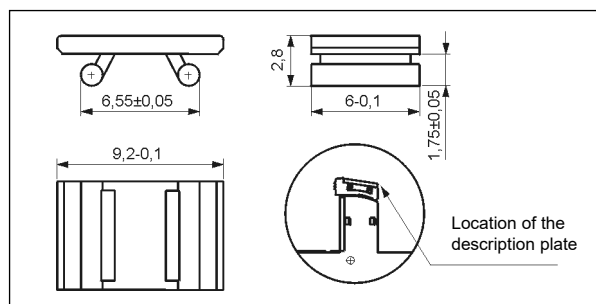

Description plate PI6W-1246

PRECAUTIONS:

1. Ensure that the parameters of the product described in its specification provide a safety margin for the appropriate operation of the device or system and never use the product in circumstances which exceed the parameters of the product. 2. Never touch any live parts of the device. 3. Ensure that the product has been connected correctly. An incorrect connection may cause malfunction, excessive heating or risk of fire. 4. In case of any risk of any serious material loss or death or injuries of humans or animals, the devices or systems shall be designed so to equip them with double safety system to guarantee their reliable operation.

PIR6WB-1PS-...

interface relays with spring terminals

Wire connection

The drawings present the sequence of operations in course of inserting wire to the spring terminal, and the recommended screwdriver to be used for opening of case springs, comply with the DIN 5264 FORM "A".

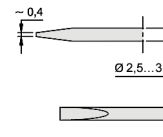
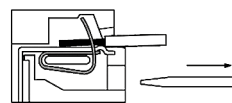
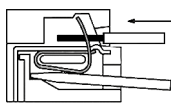
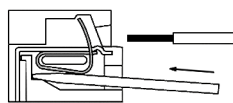
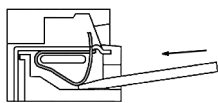

Connection diagrams

PIR6WB-1PS-...-R, PIR6WB-1PS-...-R01

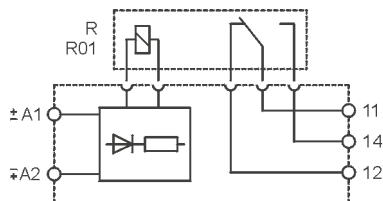

PIR6WB-1P-230V...-10

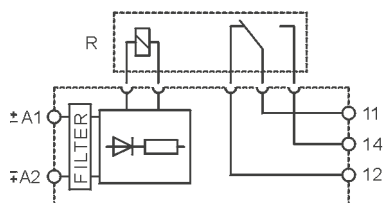

PIR6WB-1PS-...-T, PIR6WB-1PS-...-C, PIR6WB-1PS-...-O

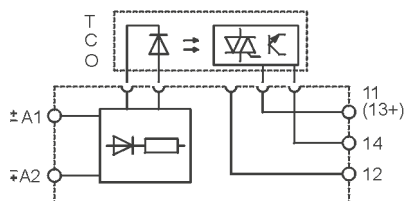

Mounting

Relays **PIR6WB-1PS-...** Ⓞ are designed for direct mounting on 35 mm rail mount acc. to EN 60715. **Connections:** max. cross section of the cables: 1 x 0,22...2,5 mm² (1 x 24...14 AWG), stripping length: 9 mm.

Interface relay **PIR6WB-1PS-...** consists of: spring terminals universal socket, with electronic **PI6WB-1PS-...**, miniature operational relay - electromagnetic **RM699BV** or solid state **RSR30** Ⓞ.

PIR6WB-1PS-... may be linked with 20-pole interconnection strip type **ZG20**. Strip **ZG20** bridges common input or output signals, maximum permissible current is 36 A / 250 V AC. Colours of strips: **ZG20-1** red, **ZG20-2** black, **ZG20-3** blue. Description plates of **PI6W-1246** type are offered for **PIR6WB-1PS-...** relays; they are delivered with the relays, not mounted.

Ⓞ Type of outputs: **R** - contacts AgSnO₂; **R01** - contacts AgSnO₂/Au hard gold plating; **T** - triac; **C** - transistor; **O** - transistor. Ⓞ For versions 230VAC/DC and 230VAC/DC-10: the distance at least 5 mm between the mounting relays.

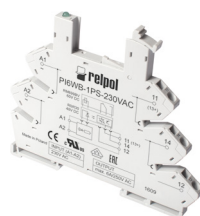

PI6WB-1PS-...



RM699BV



RSR30



ZG20



PI6W-1246

Ordering codes

Ordering codes **PIR6WB-1PS-...** are specified in Table 1, "Interface relay code" column.

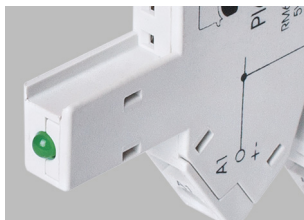

Green LED:
signalling the operation status of the relay.

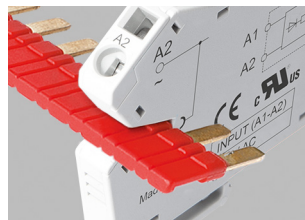

Interconnection strip ZG20:
bridging of common input or output signals.



Movable ejector: protection and easy replacement of the operational relay.

PIR6WB-1PS-...

interface relays with spring terminals

Table of codes

Table 1

Interface relay code	Rated input voltage U_n ⑦	Power of input circuit	Socket code	Operational relay code	Rated voltage of operational relay U_s ⑦
PIR6WB-1PS-6VDC-R	6 V DC	0,3 W	PI6WB-1PS-6VDC	RM699BV-3011-85-1005	5 V DC
PIR6WB-1PS-12VDC-R	12 V DC	0,2 W	PI6WB-1PS-12/24VDC	RM699BV-3011-85-1012	12 V DC
PIR6WB-1PS-24VDC-R	24 V DC	0,3 W	PI6WB-1PS-12/24VDC	RM699BV-3011-85-1024	24 V DC
PIR6WB-1PS-36VDC-R	36 V DC	0,3 W	PI6WB-1PS-36VDC	RM699BV-3011-85-1024	24 V DC
PIR6WB-1PS-48VDC-R	48 V DC	0,4 W	PI6WB-1PS-48VDC	RM699BV-3011-85-1024	24 V DC
PIR6WB-1PS-60VDC-R	60 V DC	0,5 W	PI6WB-1PS-60VDC	RM699BV-3011-85-1024	24 V DC
PIR6WB-1PS-24VAC/DC-R	24 V AC/DC	0,5 VA / 0,4 W	PI6WB-1PS-24VAC/DC	RM699BV-3011-85-1012	12 V DC
PIR6WB-1PS-42VAC/DC-R	42 V AC/DC	0,5 VA / 0,4 W	PI6WB-1PS-42VAC/DC	RM699BV-3011-85-1024	24 V DC
PIR6WB-1PS-115VAC/DC-R	115 V AC/DC	1,2 VA / 1,2 W	PI6WB-1PS-115VAC/DC	RM699BV-3011-85-1024	24 V DC
PIR6WB-1PS-230VAC/DC-R ⑧	230 V AC/DC	1,2 VA / 1,2 W	PI6WB-1PS-230VAC/DC	RM699BV-3011-85-1060	60 V DC
PIR6WB-1PS-230VAC-R	230 V AC	≤ 0,8 VA	PI6WB-1PS-230VAC	RM699BV-3011-85-1060	60 V DC
PIR6WB-1P-230VAC/DC-10 ④ ⑥	230 V AC/DC	2,1 VA / 1,0 W	PI6WB-1P-230VAC/DC-10	RM699BV-3011-85-1060	60 V DC
PIR6WB-1P-230VAC-10 ④	230 V AC	≤ 0,9 VA	PI6WB-1P-230VAC-10	RM699BV-3011-85-1060	60 V DC
PIR6WB-1PS-6VDC-R01 ⑨	6 V DC	0,3 W	PI6WB-1PS-6VDC	RM699BV-3211-85-1005	5 V DC
PIR6WB-1PS-12VDC-R01 ⑨	12 V DC	0,2 W	PI6WB-1PS-12/24VDC	RM699BV-3211-85-1012	12 V DC
PIR6WB-1PS-24VDC-R01 ⑨	24 V DC	0,3 W	PI6WB-1PS-12/24VDC	RM699BV-3211-85-1024	24 V DC
PIR6WB-1PS-36VDC-R01 ⑨	36 V DC	0,3 W	PI6WB-1PS-36VDC	RM699BV-3211-85-1024	24 V DC
PIR6WB-1PS-48VDC-R01 ⑨	48 V DC	0,4 W	PI6WB-1PS-48VDC	RM699BV-3211-85-1024	24 V DC
PIR6WB-1PS-60VDC-R01 ⑨	60 V DC	0,5 W	PI6WB-1PS-60VDC	RM699BV-3211-85-1024	24 V DC
PIR6WB-1PS-24VAC/DC-R01 ⑨	24 V AC/DC	0,5 VA / 0,4 W	PI6WB-1PS-24VAC/DC	RM699BV-3211-85-1012	12 V DC
PIR6WB-1PS-42VAC/DC-R01 ⑨	42 V AC/DC	0,5 VA / 0,4 W	PI6WB-1PS-42VAC/DC	RM699BV-3211-85-1024	24 V DC
PIR6WB-1PS-115VAC/DC-R01 ⑨	115 V AC/DC	1,2 VA / 1,2 W	PI6WB-1PS-115VAC/DC	RM699BV-3211-85-1024	24 V DC
PIR6WB-1PS-230VAC/DC-R01 ⑨ ⑧	230 V AC/DC	1,2 VA / 1,2 W	PI6WB-1PS-230VAC/DC	RM699BV-3211-85-1060	60 V DC
PIR6WB-1PS-230VAC-R01 ⑨	230 V AC	≤ 0,8 VA	PI6WB-1PS-230VAC	RM699BV-3211-85-1060	60 V DC
PIR6WB-1PS-6VDC-T	6 V DC	0,2 W	PI6WB-1PS-6VDC	RSR30-D05-A1-24-020-1	5 V DC
PIR6WB-1PS-12VDC-T	12 V DC	0,2 W	PI6WB-1PS-12/24VDC	RSR30-D12-A1-24-020-1	12 V DC
PIR6WB-1PS-24VDC-T	24 V DC	0,3 W	PI6WB-1PS-12/24VDC	RSR30-D24-A1-24-020-1	24 V DC
PIR6WB-1PS-36VDC-T	36 V DC	0,3 W	PI6WB-1PS-36VDC	RSR30-D24-A1-24-020-1	24 V DC
PIR6WB-1PS-48VDC-T	48 V DC	0,4 W	PI6WB-1PS-48VDC	RSR30-D24-A1-24-020-1	24 V DC
PIR6WB-1PS-60VDC-T	60 V DC	0,5 W	PI6WB-1PS-60VDC	RSR30-D24-A1-24-020-1	24 V DC
PIR6WB-1PS-24VAC/DC-T	24 V AC/DC	0,5 VA / 0,4 W	PI6WB-1PS-24VAC/DC	RSR30-D12-A1-24-020-1	12 V DC
PIR6WB-1PS-42VAC/DC-T	42 V AC/DC	0,5 VA / 0,4 W	PI6WB-1PS-42VAC/DC	RSR30-D24-A1-24-020-1	24 V DC
PIR6WB-1PS-115VAC/DC-T	115 V AC/DC	1,0 VA / 1,0 W	PI6WB-1PS-115VAC/DC	RSR30-D24-A1-24-020-1	24 V DC
PIR6WB-1PS-6VDC-C	6 V DC	0,2 W	PI6WB-1PS-6VDC	RSR30-D05-D1-04-025-1	5 V DC
PIR6WB-1PS-12VDC-C	12 V DC	0,2 W	PI6WB-1PS-12/24VDC	RSR30-D12-D1-04-025-1	12 V DC
PIR6WB-1PS-24VDC-C	24 V DC	0,3 W	PI6WB-1PS-12/24VDC	RSR30-D24-D1-04-025-1	24 V DC
PIR6WB-1PS-36VDC-C	36 V DC	0,3 W	PI6WB-1PS-36VDC	RSR30-D24-D1-04-025-1	24 V DC
PIR6WB-1PS-48VDC-C	48 V DC	0,4 W	PI6WB-1PS-48VDC	RSR30-D24-D1-04-025-1	24 V DC
PIR6WB-1PS-60VDC-C	60 V DC	0,5 W	PI6WB-1PS-60VDC	RSR30-D24-D1-04-025-1	24 V DC
PIR6WB-1PS-24VAC/DC-C	24 V AC/DC	0,5 VA / 0,4 W	PI6WB-1PS-24VAC/DC	RSR30-D12-D1-04-025-1	12 V DC
PIR6WB-1PS-42VAC/DC-C	42 V AC/DC	0,5 VA / 0,4 W	PI6WB-1PS-42VAC/DC	RSR30-D24-D1-04-025-1	24 V DC
PIR6WB-1PS-115VAC/DC-C	115 V AC/DC	1,0 VA / 1,0 W	PI6WB-1PS-115VAC/DC	RSR30-D24-D1-04-025-1	24 V DC
PIR6WB-1PS-230VAC/DC-C ⑧	230 V AC/DC	1,0 VA / 1,0 W	PI6WB-1PS-230VAC/DC	RSR30-D48-D1-04-025-1	48 V DC
PIR6WB-1PS-230VAC-C	230 V AC	≤ 0,8 VA	PI6WB-1PS-230VAC	RSR30-D48-D1-04-025-1	48 V DC
PIR6WB-1PS-6VDC-O	6 V DC	0,2 W	PI6WB-1PS-6VDC	RSR30-D05-D1-02-040-1	5 V DC
PIR6WB-1PS-12VDC-O	12 V DC	0,2 W	PI6WB-1PS-12/24VDC	RSR30-D12-D1-02-040-1	12 V DC
PIR6WB-1PS-24VDC-O	24 V DC	0,3 W	PI6WB-1PS-12/24VDC	RSR30-D24-D1-02-040-1	24 V DC
PIR6WB-1PS-36VDC-O	36 V DC	0,3 W	PI6WB-1PS-36VDC	RSR30-D24-D1-02-040-1	24 V DC
PIR6WB-1PS-48VDC-O	48 V DC	0,4 W	PI6WB-1PS-48VDC	RSR30-D24-D1-02-040-1	24 V DC
PIR6WB-1PS-60VDC-O	60 V DC	0,5 W	PI6WB-1PS-60VDC	RSR30-D24-D1-02-040-1	24 V DC
PIR6WB-1PS-24VAC/DC-O	24 V AC/DC	0,5 VA / 0,4 W	PI6WB-1PS-24VAC/DC	RSR30-D12-D1-02-040-1	12 V DC
PIR6WB-1PS-42VAC/DC-O	42 V AC/DC	0,5 VA / 0,4 W	PI6WB-1PS-42VAC/DC	RSR30-D24-D1-02-040-1	24 V DC
PIR6WB-1PS-115VAC/DC-O	115 V AC/DC	1,0 VA / 1,0 W	PI6WB-1PS-115VAC/DC	RSR30-D24-D1-02-040-1	24 V DC
PIR6WB-1PS-230VAC/DC-O ⑧	230 V AC/DC	1,0 VA / 1,0 W	PI6WB-1PS-230VAC/DC	RSR30-D48-D1-02-040-1	48 V DC
PIR6WB-1PS-230VAC-O	230 V AC	≤ 0,8 VA	PI6WB-1PS-230VAC	RSR30-D48-D1-02-040-1	48 V DC

The data in bold type relate to the standard versions of the relays. ⑧ Version with gold-plated contacts. ④ Version for long control lines (max. 300 m), with anti-interference filter. ⑥ For versions 230VAC/DC and 230VAC/DC-10: the distance at least 5 mm between the relays mounted side by side. ⑦ It shall be remarked that rated input voltage of the operational relay U_s not always complies with the rated input voltage U_n (which is important on ordering operational relays for sockets).