

PIR4 with socket GZP4



interface relays with Push-in terminals

R4N (AC) + GZP4





R4N (DC) + GZP4



- Interface relay **PIR4 with socket GZP4** consists of: electromagnetic relay **R4N**, grey plug-in socket **GZP4**, signalling / protecting module type **M...**, retainer / retractor clip **GZP4-0400** (plastic)
- 35 mm rail mount acc. to EN 60715 or on panel mounting with two M3 screws
- May be linked with interconnection strips type **ZGZP...**
- Recognitions, certifications, directives: recognitions R4N, RoHS,   

Contact data

Number and type of contacts	4 CO		
Contact material	AgNi , AgNi/Au hard gold plating		
Rated / max. switching voltage	AC	250 V / 300 V	
Min. switching voltage	5 V		
Rated load (capacity)	AC1	7 A / 230 V AC (VDE) 6 A / 250 V AC	
	AC15	1,5 A / 120 V 0,75 A / 240 V (C300)	
	DC1	6 A / 24 V DC (see Fig. 3)	
	DC13	0,22 A / 120 V 0,1 A / 250 V (R300)	
Motor load	acc. to UL 508	1/3 HP 240 V AC, 3,6 FLA, single-phase motor 	
	AC3 acc. to IEC 60947-4-1	0,125 kW 240 V AC, single-phase motor	
Min. switching current	5 mA		
Max. inrush current	12 A		
Rated current	6 A		
Max. breaking capacity	AC1	1 500 VA	
Min. breaking capacity	0,3 W AgNi, 0,1 W AgNi/Au hard gold plating		
Contact resistance	≤ 100 mΩ		
Max. operating frequency	• at rated load AC1	1 200 cycles/hour	
	• no load	18 000 cycles/hour	
Coil data			
Rated voltage	50/60 Hz AC	12, 24 , 48, 120, 230 V	
	DC	12, 24 , 48, 110 V	
Must release voltage	AC: ≥ 0,2 U _n DC: ≥ 0,1 U _n		
Operating range of supply voltage	see Tables 1,2 and Fig. 4, 5		
Rated power consumption	AC	50 Hz: 1,6 VA 60 Hz: 1,3 VA	
	DC	0,9 W	
Insulation according to EN 60664-1			
Insulation rated voltage	300 V AC		
Rated surge voltage	2 500 V 1,2 / 50 μs		
Overvoltage category	II		
Insulation pollution degree	2		
Dielectric strength	• between coil and contacts	2 500 V AC type of insulation: basic	
	• contact clearance	1 500 V AC type of clearance: micro-disconnection	
	• pole - pole	2 000 V AC type of insulation: basic	
Contact - coil distance	• clearance	≥ 1,6 mm	
	• creepage	≥ 3,2 mm	
General data			
Operating / release time (typical values)	AC: 10 ms / 8 ms DC: 13 ms / 3 ms		
Electrical life	• resistive AC1	> 10 ⁵ 6 A, 250 V AC	
	• cosφ	see Fig. 2	
Mechanical life (cycles)	> 2 x 10 ⁷		
Dimensions (L x W x H)	97 x 31 x 75,8 mm		
Weight	117 g		
Ambient temperature	• storage	-40...+85 °C	
	• operating	AC: -40...+55 °C DC: -40...+70 °C	
Cover protection category	IP 20 EN 60529		
Environmental protection	R4N: RTI GZP4: RT0 EN 61810-7		
Shock resistance	(NO/NC)	10 g / 5 g	
Vibration resistance	5 g 10...150 Hz		

The data in bold type relate to the standard versions of the relays.

 For single phase motors for 110-120 V AC do not use motors with higher FLA than given for 240 V AC.

PIR4 with socket GZP4 interface relays with Push-in terminals

Dimensions

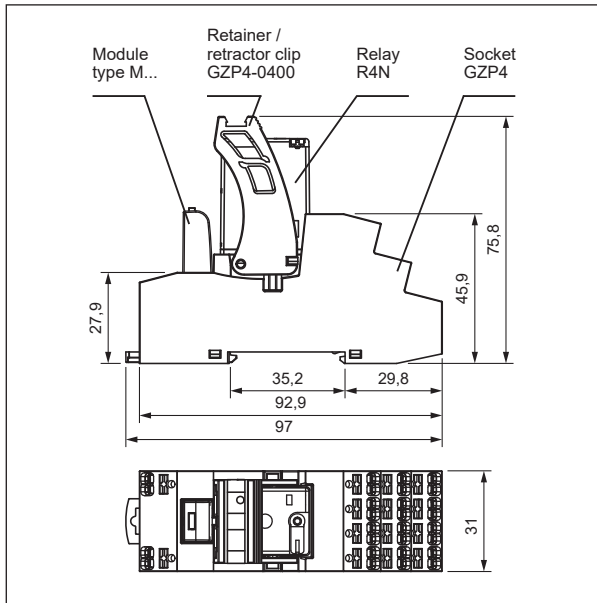

Electrical life at AC resistive load. Switching frequency: 1 200 cycles/hour

Fig. 1

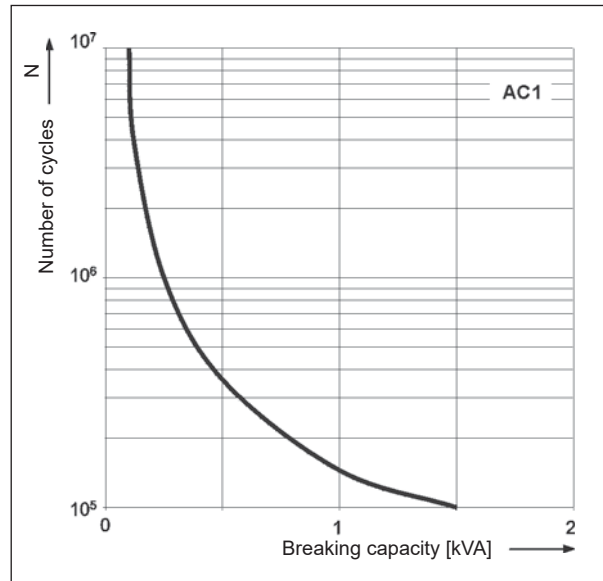

Connection diagrams (Push-in terminals side view)

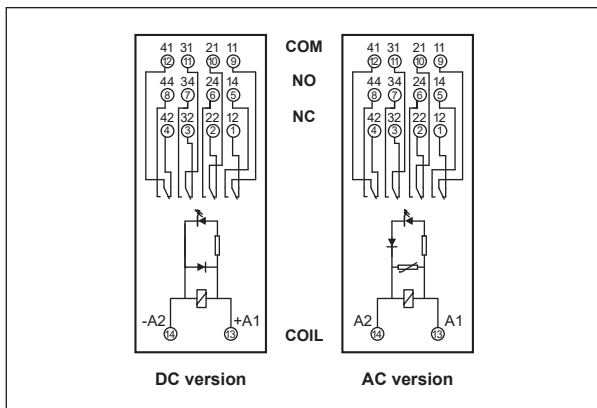

Electrical life reduction factor at AC inductive load

Fig. 2

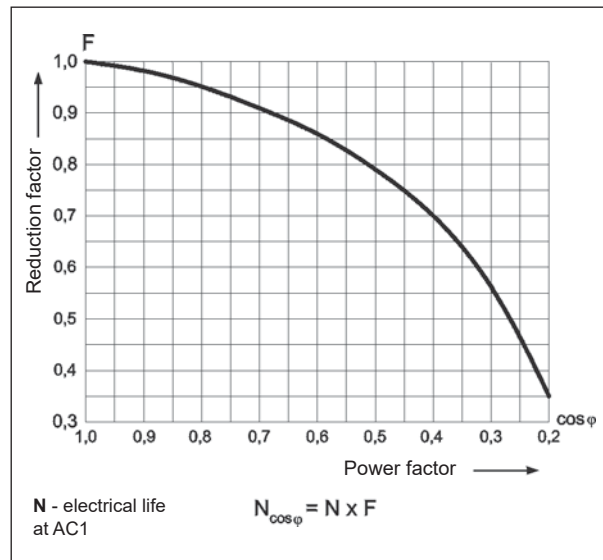

Wire connection

The drawings present inserting wire into the Push-in terminal and removing wire using the button releasing a clamp (assembly without tools).

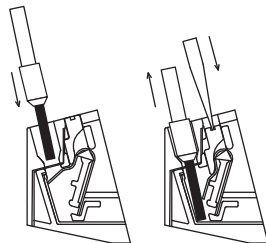

PIR4 with socket GZP4 interface relays with Push-in terminals

Max. DC breaking capacity
A - resistive load DC1
B - inductive load L/R = 40 ms

Fig. 3

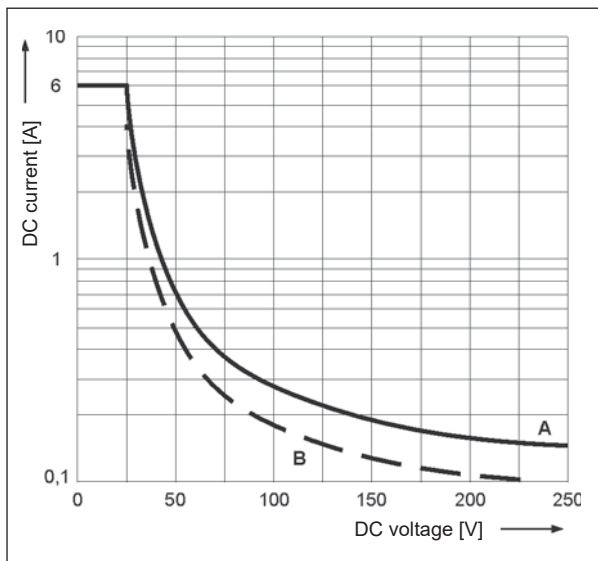

Coil operating range - DC

Fig. 4

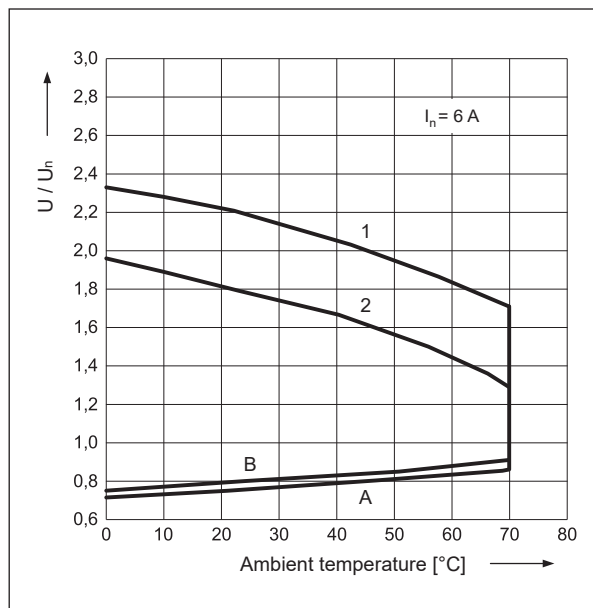

Coil operating range - AC 50 Hz

Fig. 5

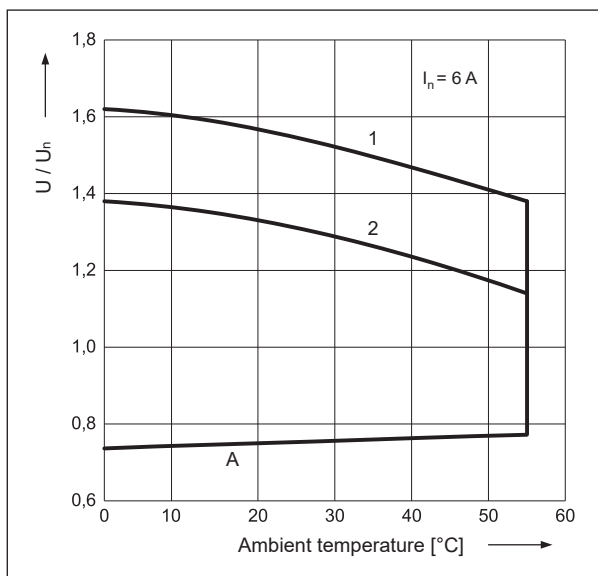

Description of Fig. 4 and 5

A - relations between make voltage and ambient temperature at no load on contacts. Coil temperature and ambient temperature are equal before coil energizing. Make voltage is not higher than the value read on Y axis (multiplication of rated voltage).

B - relations between make voltage and ambient temperature after initial coil heating up with $1,1 U_n$, at continues load of I_n on contacts. Make voltage is not higher than the value read on Y axis (multiplication of rated voltage).

1, 2 - values on Y axis represent allowed overvoltage on coil at certain ambient temperature and contact load:

- 1** - no load
- 2** - rated load

PIR4 with socket GZP4 interface relays with Push-in terminals

Mounting

Relays **PIR4 with socket GZP4** are designed for direct mounting on 35 mm rail mount acc. to EN 60715 or on panel mounting with two M3 screws. **Connections:** max. cross section of the cables: 2 x 1,5 mm² (ferrules without insulation), 2 x 1 mm² (ferrules with insulation), stripping length: 8...10 mm.

Plug-in sockets **GZP4** may be linked with interconnection strips type **ZGZP...** Strip **ZGZP4-8** bridges common input signals, maximum permissible current is 10 A / 250 V AC, possibility of connection of 8 sockets. Strip **ZGZP4-2** bridges common input or output signals, possibility of connection of 2+n sockets. Jumper **ZGZP-2** bridges the neighboring poles of single socket **GZP4**. Colours of strips: **ZGZP...GY** grey, **ZGZP...BK** black, **ZGZP...RD** red, **ZGZP...BE** blue (see page 6).

Description plates **MP15**, snap into tall marker groove, compatible with the standard for DIN rail terminal blocks, should be ordered separately.



Terminals directed to wiring ducts: esthetic cabling management, easier content reading from markers on wires.



Holes for test probes: ergonomic, stable position of the probe in the socket, freedom to perform measurements and control.



Space for label: for self-adhesive paper, foil or polyester tapes (max. width 9 mm).

Coil data - DC voltage version

Table 1

Coil code	Rated voltage V DC	Coil resistance at 20 °C Ω	Acceptable resistance	Coil operating range V DC	
				min. (at 20 °C)	max. (at 70 °C)
012DC	12	160	± 10%	9,6	13,2
024DC	24	640	± 10%	19,2	26,4
048DC	48	2 600	± 10%	38,4	52,8
110DC	110	13 600	± 10%	88,0	121,0

The data in bold type relate to the standard versions of the relays.

Coil data - AC 50/60 Hz voltage version

Table 2

Coil code	Rated voltage V AC	Coil resistance at 20 °C Ω	Acceptable resistance	Coil operating range V AC	
				min. (at 20 °C)	max. (at 55 °C)
012AC	12	39,5	± 10%	9,6	13,2
024AC	24	158	± 10%	19,2	26,4
048AC	48	640	± 10%	38,4	52,8
120AC	120	3 770	± 10%	96,0	132,0
230AC	230	16 100	± 10%	184,0	253,0

The data in bold type relate to the standard versions of the relays.

PIR4 with socket GZP4 interface relays with Push-in terminals

Ordering codes

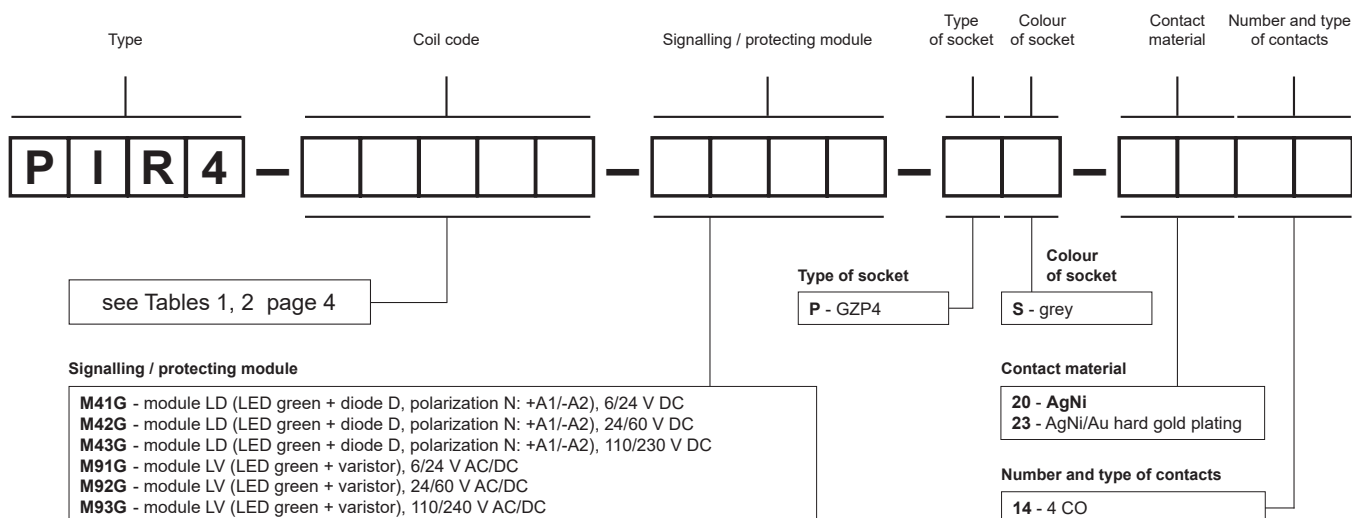

Examples of ordering codes:

PIR4-024DC-M41G-PS-2014

interface relay **PIR4** consists of: relay **R4N** (four changeover contacts, contact material AgNi, coil voltage 24 V DC), socket **GZP4** (grey, Push-in terminals), signalling / protecting module **M41G** (version LD), retainer / retractor clip **GZP4-0400** (red, plastic)

PIR4-230AC-M93G-PS-2314

interface relay **PIR4** consists of: relay **R4N** (four changeover contacts, contact material AgNi/Au hard gold plating, coil voltage 230 V AC 50/60 Hz), socket **GZP4** (grey, Push-in terminals), signalling / protecting module **M93G** (version LV), retainer / retractor clip **GZP4-0400** (red, plastic)

PRECAUTIONS:

1. Ensure that the parameters of the product described in its specification provide a safety margin for the appropriate operation of the device or system and never use the product in circumstances which exceed the parameters of the product. 2. Never touch any live parts of the device. 3. Ensure that the product has been connected correctly. An incorrect connection may cause malfunction, excessive heating or risk of fire. 4. In case of any risk of any serious material loss or death or injuries of humans or animals, the devices or systems shall be designed so to equip them with double safety system to guarantee their reliable operation.

23.12.2020

Interconnection strips ZGZP...

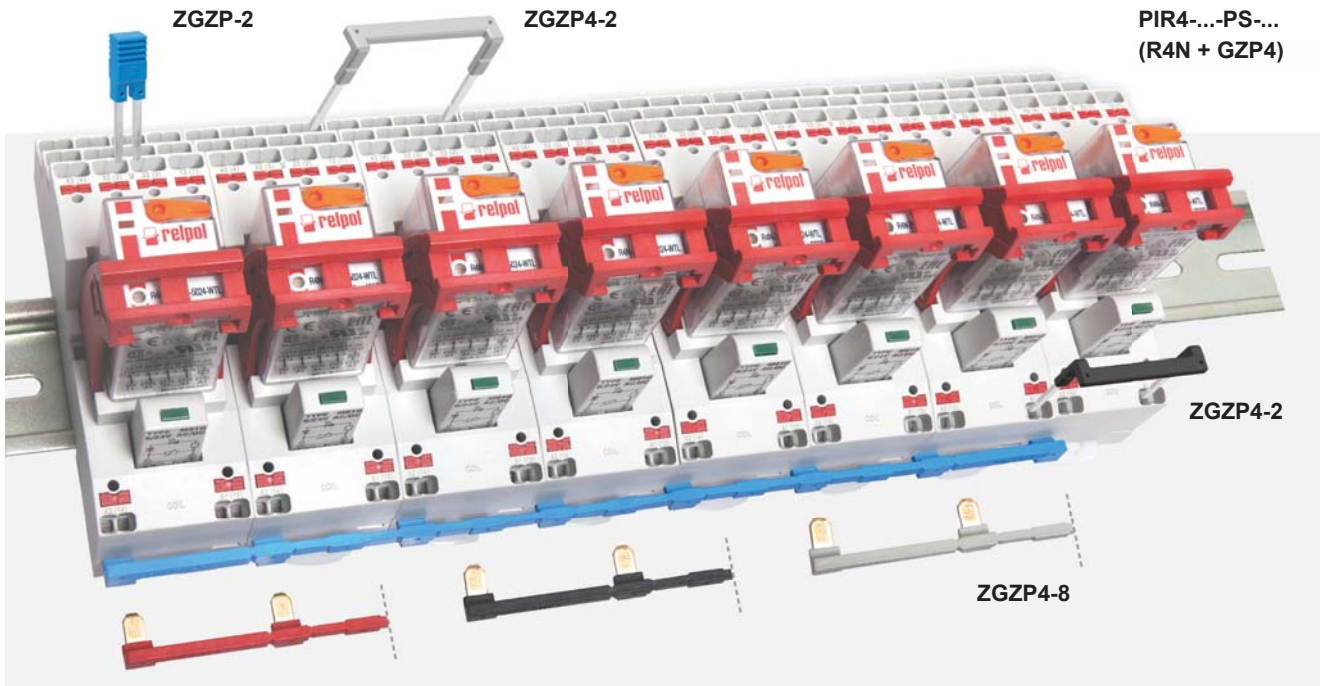

■ ZGZP... for:

Plug-in sockets	Relays for plug-in sockets	Interface relays ⓘ
GZP4	R2N	PIR2-...-PS-... (R2N + GZP4)
	R4N	PIR4-...-PS-... (R4N + GZP4)

ⓘ Interface relay **PIR2** (**PIR4**) is offered as a **set**: electromagnetic relay **R2N** (**R4N**) + plug-in socket **GZP4** + signalling / protecting module type **M...** + retainer / retractor clip **GZP4-0400**.

■ Interconnection strips ZGZP...

- designed for the co-operation with plug-in sockets of miniature industrial relays and with interface relays PIR2 and PIR4, which are equipped with screw terminals; sockets and relays are mounted on 35 mm rail mount acc. to EN 60715,
- strip **ZGZP4-8** bridges common input signals (coil terminals A1 or A2), maximum permissible current is 10 A / 250 V AC, possibility of connection of 8 sockets or relays,



- strip **ZGZP4-2** bridges common input signals (coil terminals A1 or A2) or output signals, possibility of connection of 2+n sockets or relays,

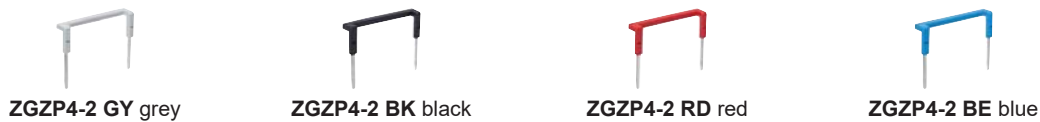

- jumper **ZGZP-2** bridges the neighboring poles of single socket **GZP4**.

