

PI84 with socket GZP80 interface relays with Push-in terminals

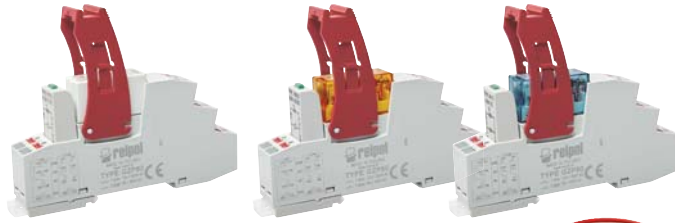



RM84 + GZP80

RM84 (AC) ① + GZP80

RM84 (DC) ① + GZP80



NEW

- Interface relay **PI84 with socket GZP80** consists of: electromagnetic relay **RM84** (standard white or option transparent: AC orange, DC blue ①), grey plug-in socket **GZP80**, signalling / protecting module type **M...**, retainer / retractor clip **GZP80-0400** (plastic)
- 35 mm rail mount acc. to EN 60715 or on panel mounting with one M3 screw • May be linked with interconnection strips type **ZGZP...**
- Recognitions, certifications, directives: recognitions RM84, RoHS,    

Contact data

Number and type of contacts		2 CO
Contact material		AgNi , AgNi/Au hard gold plating
Rated / max. switching voltage	AC	250 V / 300 V
Min. switching voltage		5 V
Rated load (capacity)	AC1	8 A / 250 V AC
	AC15	3 A / 120 V 1,5 A / 240 V (B300)
	DC1	8 A / 24 V DC (see Fig. 3)
	DC13	0,22 A / 120 V 0,1 A / 250 V (R300)
Motor load	acc. to UL 508	1/3 HP 240 V AC, 3,6 FLA, single-phase motor ②
	AC3 acc. to IEC 60947-4-1	0,37 kW 240 V AC, single-phase motor
Min. switching current		5 mA AgNi, 2 mA AgNi/Au hard gold plating
Max. inrush current		15 A
Rated current		8 A
Max. breaking capacity	AC1	2 000 VA
Min. breaking capacity		0,3 W AgNi, 0,05 W AgNi/Au hard gold plating
Contact resistance		≤ 100 mΩ
Max. operating frequency	• at rated load AC1 • no load	600 cycles/hour 72 000 cycles/hour

Coil data

Rated voltage	50/60 Hz AC	12, 24 , 48, 120, 230 V
	DC	12, 24 , 48, 110 V
Must release voltage		AC: ≥ 0,15 U _n DC: ≥ 0,1 U _n
Operating range of supply voltage		see Tables 1, 2 and Fig. 4, 5
Rated power consumption	AC	0,75 VA
	DC	0,4 ... 0,48 W

Insulation according to EN 60664-1

Insulation rated voltage		250 V AC
Rated surge voltage		4 000 V 1,2 / 50 μs
Overvoltage category		III
Insulation pollution degree		3
Dielectric strength	• between coil and contacts • contact clearance • pole - pole	5 000 V AC type of insulation: reinforced 1 000 V AC type of clearance: micro-disconnection 2 500 V AC type of insulation: basic
Contact - coil distance	• clearance • creepage	≥ 10 mm ≥ 10 mm

General data

Operating / release time (typical values)		7 ms / 3 ms
Electrical life	• resistive AC1 • cosφ • DC L/R=40 ms	> 10 ⁵ 8 A, 250 V AC see Fig. 2 > 10 ⁵ 0,15 A, 220 V DC
Mechanical life (cycles)		> 3 x 10 ⁷
Dimensions (L x W x H)		97 x 15,9 x 75,8 mm
Weight		65 g
Ambient temperature	• storage (non-condensation and/or icing) • operating	-40...+85 °C AC: -40...+70 °C DC: -40...+85 °C -20...+70 °C ①
Cover protection category		IP 20 EN 60529
Environmental protection		RM84: RTII GZP80: RT0 EN 61810-7
Shock resistance		20 g
Vibration resistance	(NO/NC)	10 g / 5 g 10...150 Hz

The data in bold type relate to the standard versions of the relays. ① Special versions - relays in transparent cover, operating temperature -20...+70 °C. See "Ordering codes". ② For single phase motors for 110-120 V AC do not use motors with higher FLA than given for 240 V AC.

PI84 with socket GZP80 interface relays with Push-in terminals

Dimensions

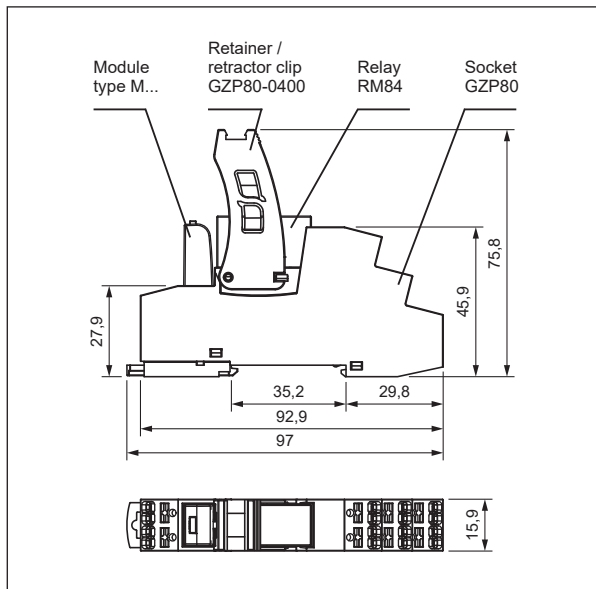

Connection diagrams (Push-in terminals side view)

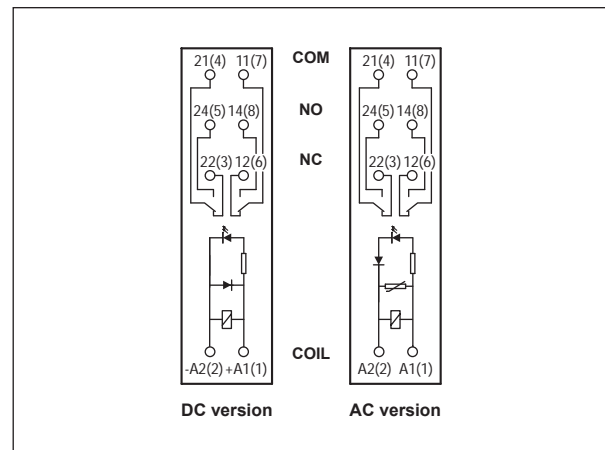

Wire connection

The drawings present inserting wire into the Push-in terminal and removing wire using the button releasing a clamp (assembly without tools).

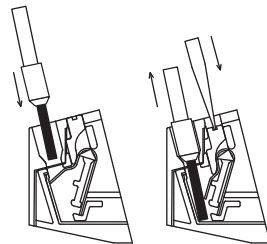

Connection of GZP80 socket

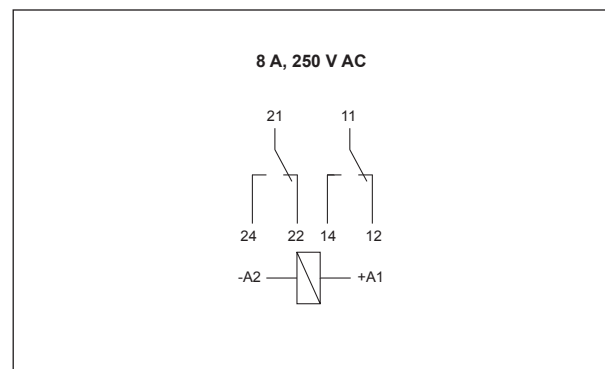

Interface relays Push-in

PI84 (PI85, PI84P, PI85P)
set: relay RM84
(RM85, RMP84, RMP85)
+ socket GZP80

PIR2 (PIR4) set:
relay R2N (R4N)
+ socket GZP4

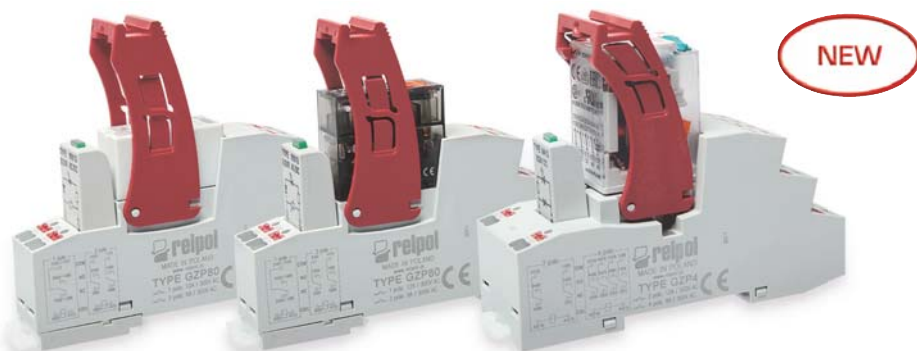

PRECAUTIONS:

1. Ensure that the parameters of the product described in its specification provide a safety margin for the appropriate operation of the device or system and never use the product in circumstances which exceed the parameters of the product. 2. Never touch any live parts of the device. 3. Ensure that the product has been connected correctly. An incorrect connection may cause malfunction, excessive heating or risk of fire. 4. In case of any risk of any serious material loss or death or injuries of humans or animals, the devices or systems shall be designed so to equip them with double safety system to guarantee their reliable operation.

23.12.2020

Electrical life at AC resistive load.
Switching frequency: 600 cycles/hour

Fig. 1

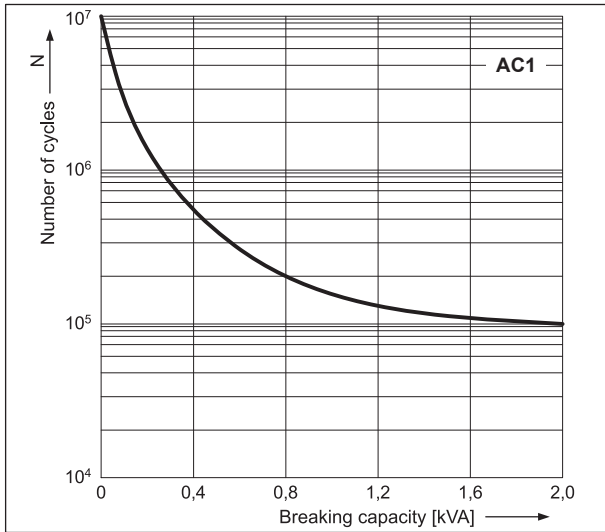

Electrical life reduction factor
at AC inductive load

Fig. 2

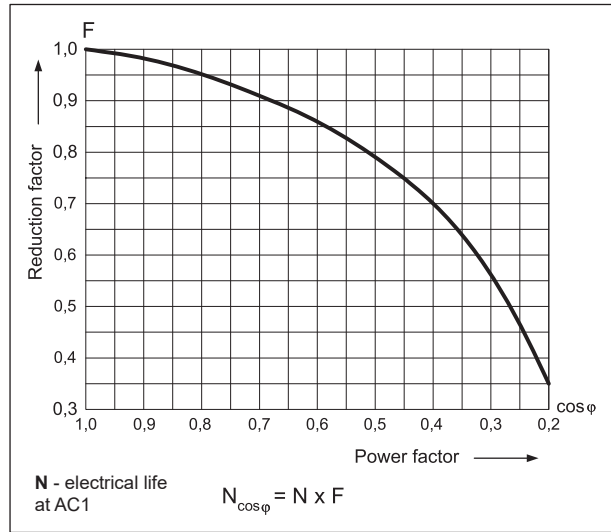

Max. DC resistive load breaking capacity

Fig. 3

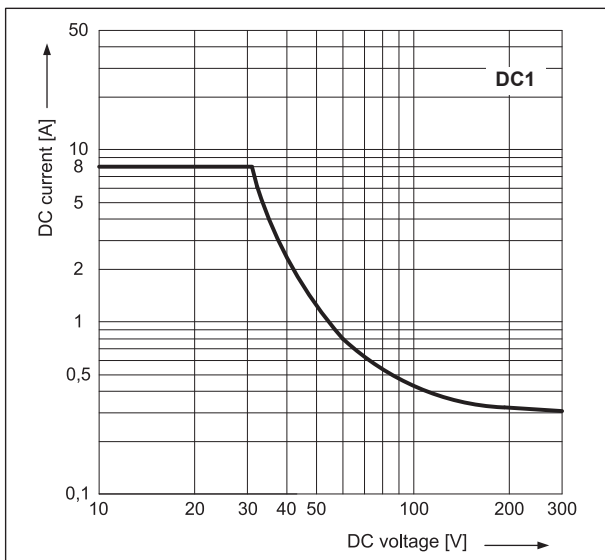

Coil operating range - DC

Fig. 4

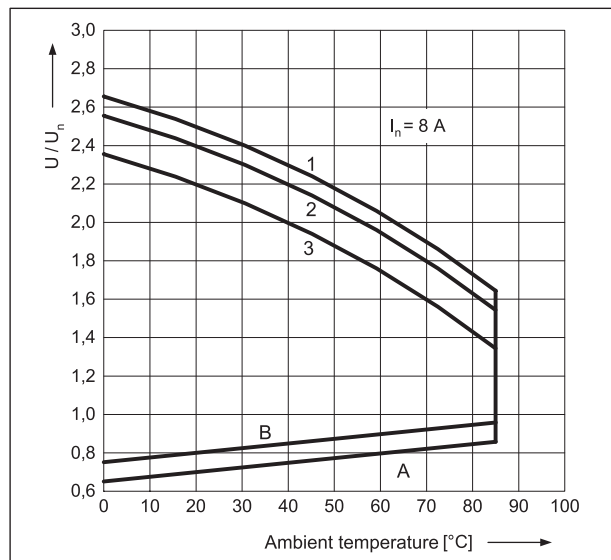

Coil operating range - AC 50 Hz

Fig. 5

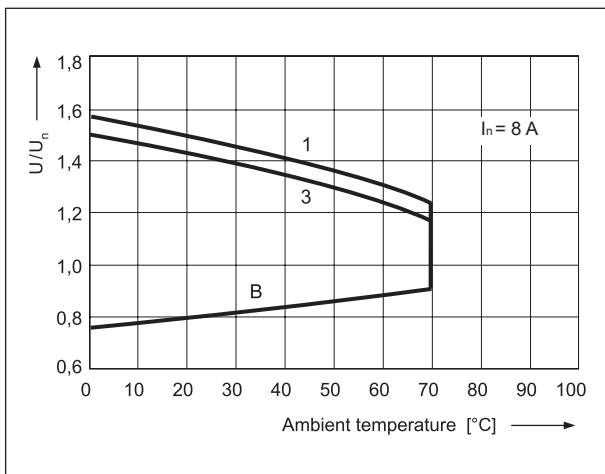

Description of Fig. 4 and 5

A - relations between make voltage and ambient temperature at no load on contacts. Coil temperature and ambient temperature are equal before coil energizing. Make voltage is not higher than the value read on Y axis (multiplication of rated voltage).

B - relations between make voltage and ambient temperature after initial coil heating up with $1,1 U_n$, at continues load of I_n on contacts. Make voltage is not higher than the value read on Y axis (multiplication of rated voltage).

1, 2, 3 - values on Y axis represent allowed overvoltage on coil at certain ambient temperature and contact load:

- 1** - no load
- 2** - 50% of rated load
- 3** - rated load

PI84 with socket GZP80

interface relays with Push-in terminals

Mounting

Relays **PI84 with socket GZP80** are designed for direct mounting on 35 mm rail mount acc. to EN 60715 or on panel mounting with one M3 screw. **Connections:** max. cross section of the cables: 2 x 1,5 mm² (ferrules without insulation), 2 x 1 mm² (ferrules with insulation), stripping length: 8...10 mm.

Plug-in sockets **GZP80** may be linked with interconnection strips type **ZGZP...** Strip **ZGZP80-8** bridges common input signals, maximum permissible current is 10 A / 250 V AC, possibility of connection of 8 sockets. Strip **ZGZP80-2** bridges common input or output signals, possibility of connection of 2+n sockets. Jumper **ZGZP-2** bridges the neighboring poles of single socket **GZP80**. Colours of strips: **ZGZP...GY** grey, **ZGZP...BK** black, **ZGZP...RD** red, **ZGZP...BE** blue (see page 6).

Description plates **MP15**, snap into tall marker groove, compatible with the standard for DIN rail terminal blocks, should be ordered separately.



Terminals directed to wiring ducts: esthetic cabling management, easier content reading from markers on wires.



Holes for test probes: ergonomic, stable position of the probe in the socket, freedom to perform measurements and control.



Space for label: for self-adhesive paper, foil or polyester tapes (max. width 9 mm).

Coil data - DC voltage version

Table 1

Coil code	Rated voltage V DC	Coil resistance at 20 °C Ω	Acceptable resistance	Coil operating range V DC	
				min. (at 20 °C)	max. (at 20 °C)
012DC	12	360	± 10%	8,4	30,6
024DC	24	1 440	± 10%	16,8	61,2
048DC	48	5 700	± 10%	33,6	122,4
110DC	110	25 200	± 10%	77,0	280,0

The data in bold type relate to the standard versions of the relays.

Coil data - AC 50/60 Hz voltage version

Table 2

Coil code	Rated voltage V AC	Coil resistance at 20 °C Ω	Acceptable resistance	Coil operating range V AC 50 Hz	
				min. (at 20 °C)	max. (at 20 °C)
012AC	12	100	± 10%	9,6	13,2
024AC	24	400	± 10%	19,2	28,8
048AC	48	1 550	± 10%	38,4	57,6
120AC	120	10 200	± 10%	96,0	144,0
230AC	230	38 500	± 10%	184,0	276,0

The data in bold type relate to the standard versions of the relays.

PI84 with socket GZP80

interface relays with Push-in terminals

Ordering codes

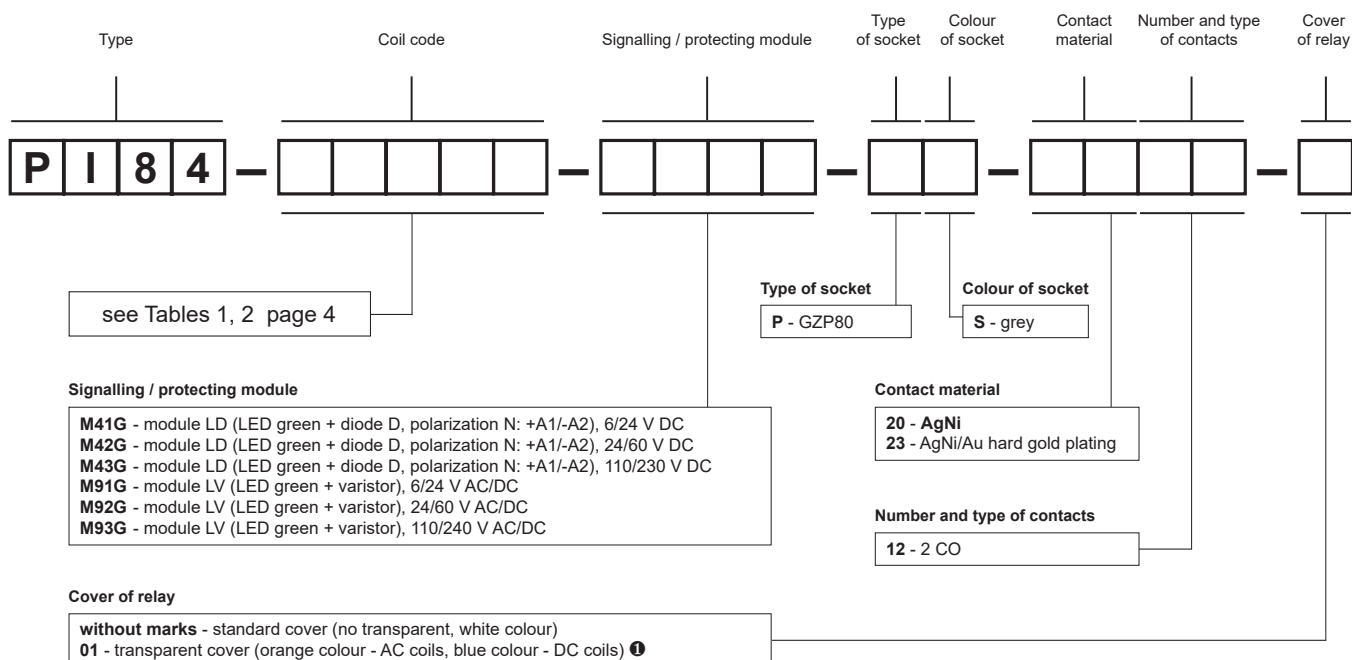

Examples of ordering codes:

PI84-230AC-M93G-PS-2012

interface relay **PI84** consists of: relay **RM84** (white, two changeover contacts, contact material AgNi, coil voltage 230 V AC 50/60 Hz), socket **GZP80** (grey, Push-in terminals), signalling / protecting module **M93G** (version LV), retainer / retractor clip **GZP80-0400** (red, plastic)

PI84-024AC-M91G-PS-2312-01

interface relay **PI84** consists of: relay **RM84** (orange, two changeover contacts, contact material AgNi/Au hard gold plating, coil voltage 24 V AC 50/60 Hz), socket **GZP80** (grey, Push-in terminals), signalling / protecting module **M91G** (version LV), retainer / retractor clip **GZP80-0400** (red, plastic)

PI84-024DC-M41G-PS-2012-01

interface relay **PI84** consists of: relay **RM84** (blue, two changeover contacts, contact material AgNi, coil voltage 24 V DC), socket **GZP80** (grey, Push-in terminals), signalling / protecting module **M41G** (version LD), retainer / retractor clip **GZP80-0400** (red, plastic)

PI84-230AC-M93G-PS-2012
(standard white)



PI84-024AC-M91G-PS-2312-01
(option transparent: AC orange)



PI84-024DC-M41G-PS-2012-01
(option transparent: DC blue)



Interconnection strips ZGZP...

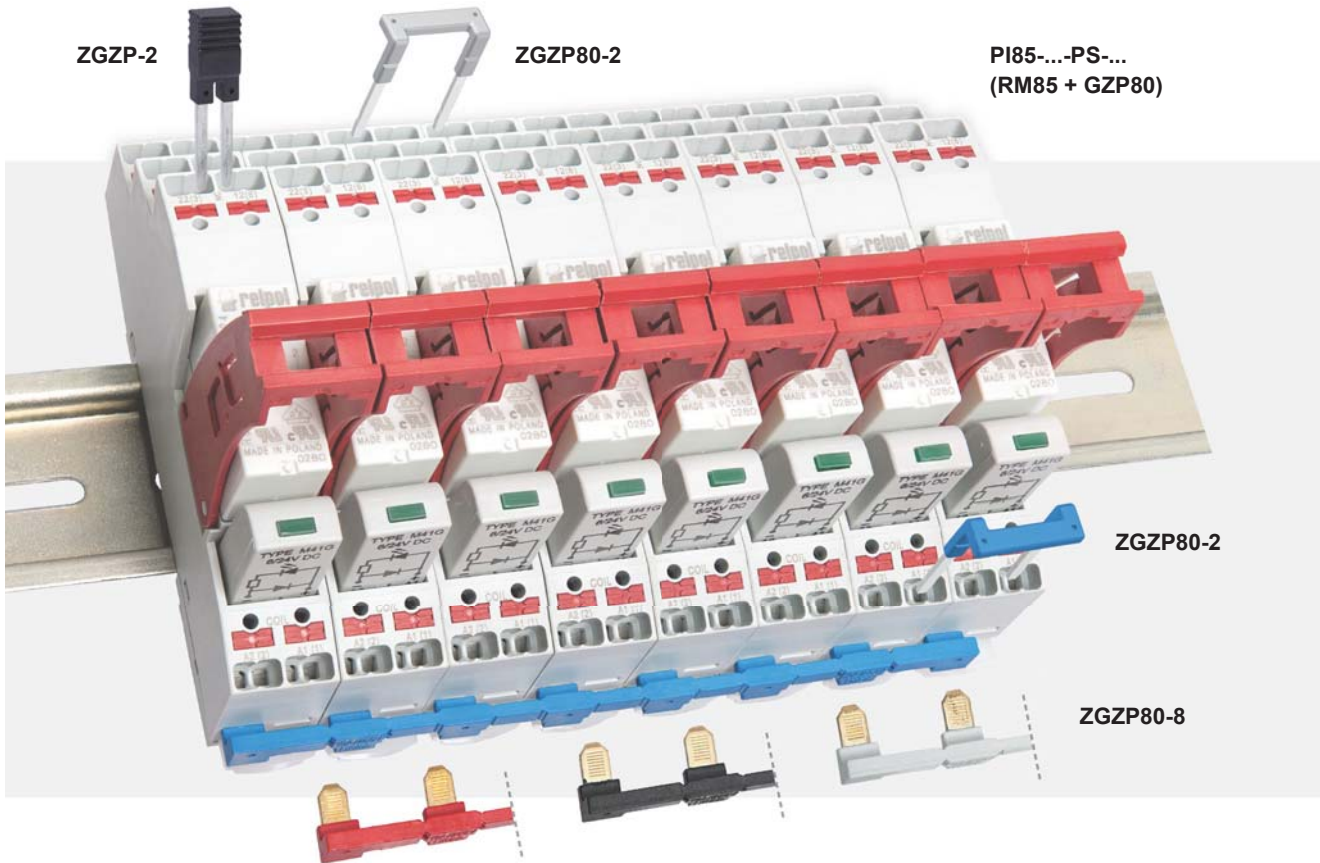

■ ZGZP... for:

Plug-in sockets	Relays for plug-in sockets	Interface relays ①
GZP80	RM84, RM85, RM85 inrush, RM85 105 °C sensitive, RM87L ②, RM87P ②, RMP84, RMP85	PI84-...-PS-... (RM84 + GZP80) PI85-...-PS-... (RM85 + GZP80) PI84P-...-PS-... (RMP84 + GZP80) PI85P-...-PS-... (RMP85 + GZP80)

① Interface relay **PI84** (**PI85**, **PI84P**, **PI85P**) is offered as a **set**: electromagnetic relay **RM84** (**RM85**, **RMP84**, **RMP85**) + plug-in socket **GZP80** + signalling / protecting module type **M...** + retainer / retractor clip **GZP80-0400**.
② Also versions RM87. sensitive

■ Interconnection strips ZGZP...

- designed for the co-operation with plug-in sockets of miniature relays and with interface relays PI84, PI85, PI84P, PI85P, which are equipped with Push-in terminals; sockets and relays are mounted on 35 mm rail mount acc. to EN 60715,
- strip **ZGZP80-8** bridges common input signals (coil terminals A1 or A2), maximum permissible current is 10 A / 250 V AC, possibility of connection of 8 sockets or relays,



ZGZP80-8 GY grey



ZGZP80-8 BK black



ZGZP80-8 RD red



ZGZP80-8 BE blue

- strip **ZGZP80-2** bridges common input signals (coil terminals A1 or A2) or output signals, possibility of connection of 2+n sockets or relays,



ZGZP80-2 GY grey



ZGZP80-2 BK black



ZGZP80-2 RD red



ZGZP80-2 BE blue

- jumper **ZGZP-2** bridges the neighboring poles of single socket **GZP80**.



ZGZP-2 GY grey



ZGZP-2 BK black



ZGZP-2 RD red



ZGZP-2 BE blue