



ABACUS SYSTEM





ABACUS SYSTEM





X

E

D

Z

I

OVERVIEW	4
ABACUS ESSE	16
CABINET CABLING RANGE	18
CABINET SERVER RANGE	22
BOX	28
ABACUS ESSE / PRO MECHANICAL ACCESSORIES	29
ABACUS ESSE / PRO VENTILATION	39
ABACUS ESSE / PRO ELECTRICAL ACCESSORIES	40
ABACUS PRO	42
CABINET	44
THERMAL MANAGEMENT	51
BOX	56
BOX ACCESSORIES	59
ABACUS PRO FOR SPECIAL APPLICATIONS	62
ABACUS DACE	74
COOLING SOLUTIONS	76
POWER DISTRIBUTION UNITS	78
KVM	80
TECHNICAL SECTION	84





MULTIPLIES THE EXPERIENCE



- 1 Enclosures for Industrial Automation
- 2 Enclosures for Harsh environments
- 3 Solutions for LV Energy distribution
- 4 Solutions for IT business

THE STORY OF ONE FAMILY'S PASSION AND PROGRESS



At ETA, the roots of innovation run deep. It's 1960: amid the general desire to rebuild after the war, Antonio Turati established his company and began teaching his children the value of products made with passion and dedication, customer focus, respect for employees, a good work ethic, and the satisfaction of designing and manufacturing something new. Over time, this family transformed these roots and values into the modern company known as ETA, a name with a modern and technological feel that's also an Italian acronym for Eredi Turati Antonio ("Heirs of Antonio Turati"). And the Turati family, now represented by the third generation, remains at the helm of the company to this day. Because only those with solid roots can look to the future with energy and passion.



THE GROUP'S FIGURES

Over **35 years** of experience in processing sheet steel, stainless steel and extruded aluminium

70.000 mq of area

Over **200 workers**

An extensive sales network that distributes ETA products to over **40 countries** worldwide

2 production sites in Italy

1 logistics centre in Italy

2 logistics centres in Europe (UK and France)

1 representative office in Russia (St. Petersburg)

1 branch office in Cyprus for the Middle East area



THE ENERGY TO INNOVATE THE AUTOMATION INDUSTRY



A strong specialization: the production of non-wired electrical panels for industrial automation and LV power distribution applications.

How does one achieve and maintain a leading position in this field?

- Advanced technology
- Certified products
- Continuously monitored business processes

These factors have led ETA to become a benchmark for the energy management sector:

- Power distribution
- Civil and industrial automation
- Management of data and telecommunications

PRODUCTS, SOLUTIONS AND TECHNOLOGIES FOR THE AUTOMATION INDUSTRY

On-board machine panels, modular and stand-alone cabinets, cases, enclosures in high-resistance low alloy sheet metal, stainless steel and aluminium.

Everything necessary to protect the equipment and to facilitate its interactions with the energy sources and the operators.

Maximum design and production flexibility for customised projects.



SOLID VALUES, WITH AN OPEN VISION

The values upon which ETA's activities are founded:

- QUALITY
- SUSTAINABLE INNOVATION
- FLEXIBILITY



QUALITY STAFF AND PRODUCTS

The absolute quality of the products is owed to the quality of the staff and the work methods.

Highly skilled and continuously updated **Personnel**
 Constantly monitored **business Processes**
 Carefully designed, meticulously built, and quality certified **Products**

High quality products must also be aesthetically pleasing. The design is therefore essential.

One example of ETA's dedication to design are the awards that the company has won for its cabinets' lever-operated handle:

- selected by the ADI Design Index 2013 in the "Design for work" category
- honourable mention at the 23rd edition of the Compasso d'Oro Awards



ISTITUTO ITALIANO DELLA SALDATURA



ENVIRONMENTAL SUSTAINABILITY

For ETA, sustainability is a global issue of economic, social, cultural and environmental importance.

In concrete terms, for example, this means **reducing annual CO² emissions** by investing in an energy-saving fibre optic laser welding technology, and by opting for the use of high-strength HSLA steels. It means using entirely recyclable materials of low environmental impact.

It also means creating the conditions necessary for professional growth, in terms of both continuing education and social realization.

FLEXIBILITY

Design and operational flexibility.

This is achieved in two ways:

- **by continuously renewing the product range** to keep pace with a constantly changing market
- **by customising our solutions based** on the customers' specific needs.

ETA has dedicated an entire department to **customised production**.



A CUSTOMER-ORIENTED COMPANY BESIDE YOU
www.eta.it



- Simple
- Fast
- Efficient

Our corporate website for HQ and Subsidiaries is designed to be easily accessible from any device (smartphone, tablet, PC) and easy to navigate. User-friendly interface, up to date contents and global communication more and more updated through the interaction with social media.

Beside you wherever you are.

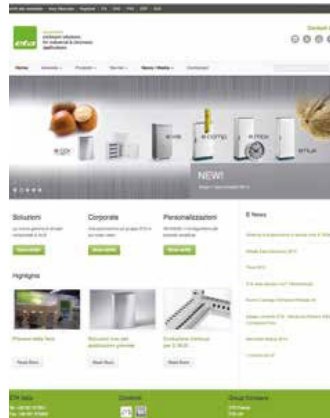

An online configurator designed to optimize the delivery of our standard-modified products: in a few simple steps, you can choose the product, customize it with special holes and painting, download drawings and send the purchase order. Everything online, without any further steps and in a few minutes!

Thanks to the advanced laser technology of the latest machinery recently installed in ETA and thanks to the use of AETAS3D, your special solution will become our standard.

FROM PRODUCT CONCEPT TO PACKAGING When protection is a must. . .



The ABACUS packaging is designed to grant maximum performance in terms of protection and differentiation.

Functionality

Greater protection and shock resistance.

Design

Image and differentiation from the competitors. Stand out from the competition approach.

Sustainability

Possibility of reuse from the distributor to the end user.



In line with the corporate philosophy of sustainability, we chose to collaborate with local consortium COMIECO (Region Lombardia) who devote particular attention to reducing the environmental impact, recycling and recovery the packaging of cellulose origin.

ABACUS: THE PAST, PRESENT AND FUTURE OF COMPUTING

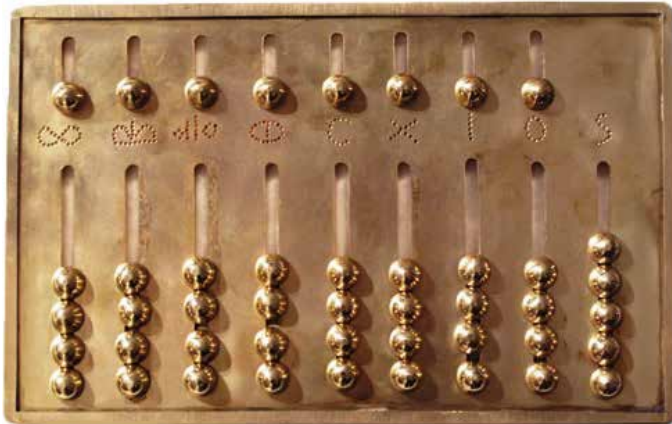

Reproduction of ancient Roman Abacus (Collezione Niccolai Firenze).

The name Abacus comes from the history of computing. An abacus is an instrument designed to perform mathematical operations, and is the first known ancestor of modern calculators and computer.

In ancient Rome, the abacus took on the form of a small bar of metal to be held in the hand, just like the modern day tablet.

And in the history of computing, Italy is one of the main protagonists. Fibonacci introduced the Western world to Arabic numerals, as well as the concepts of zero, square roots and fractions.

In the 1700s, Giovanni Poleni developed a mechanism that influenced the evolution of computing machines for centuries to come.

In 1948, Olivetti created the world's first machine capable of performing all four mathematical operations, the legendary Divisumma, which is now on display at New York's Museum of Modern Art.

Olivetti marked another historic achievement in 1965, when it introduced the world's first personal computer: the P101. What's more, a laboratory in Ivrea recently introduced the Arduino, an electronic board with open source hardware for makers and interaction designers.

Today, Italy's achievements continue with ETA and the ABACUS line.



THE ABACUS SYSTEM

ABACUS SYSTEM

A specific line of cabinets, enclosures and accessories dedicated to the fields of computing, information technology, extended networks, sharing and security.

- cabling and server solutions with IP20 protection rating > ABACUS ESSE
- modular cabinets with IP55 protection rating > ABACUS PRO
- specific solutions designed for heavy duty applications > ABACUS PRO
- solutions for Data Centres > ABACUS DACE



ABACUS SYSTEM



ABACUS ESSE range consists of solutions with protection rating IP20: designed to offer the best performance even for simplified applications, the product range includes 19" suite cabinets for cabling (available with glazed, blank or ventilated door), server suite cabinets with ventilated or glazed door and 19" wall-mounting boxes. The cabinets are available in both standard or special combination and supplied already mounted or in flat-pack version. For simplified but safe applications, ABACUS ESSE is the system for your requirements.

A B A C U S

SYSTEM

ESSE



ESSE

CABLING RANGE

CHARACTERISTICS

The profile used for uprights and crosspieces is unique, manufactured from high-strength low-alloy sheet steel (HSLA), closed with continuous fiber laser welding and free of sharp edges. The frame corners are manufactured with orthogonal joints laser welded to vertical upright rails and horizontal rails for the roof and bottom. Only 8 high resistance screws are necessary to mount the structure, while two position pins allow the easy mounting of the two parts of the joint. Panels are manufactured from sheet steel with rounded folding for higher resistance and aesthetics.

PAINT FINISH

ETA standard epoxy polyester powder coating.

- structure: RAL 7035 smooth finish
- door, rear panel and side panels: RAL 7035 textured finish
- roof: RAL 9011 textured finish.

PROTECTION RATING

IP20 complying with EN60529

NEMA 1 complying with NEMA 250



STANDARD VERSION ASSEMBLED CABINET



- structure manufactured from high-strength low-alloy sheet steel (HSLA)
- glazed door manufactured from sheet steel with tempered glass, supplied with lever-operated double bar locking system with key lock insert and two locking points
- removable roof with ventilation louvers and cable entry
- removable rear panel with quarter turns locking system
- removable side panels with quarter turns locking system
- nr. 2 front rack profiles
- nr. 4 levelling feet

ABACUS ESSE CABINET - CABLING RANGE WITH GLAZED DOOR				
CODE	HE	DIMENSIONS (MM)		
		WIDTH	HEIGHT	DEPTH
AESSE061206PV	24	600	1200	600
AESSE061606PV	33	600	1600	600
AESSE062006PV	42	600	2000	600
AESSE062206PV	47	600	2200	600
AESSE061208PV	24	600	1200	800
AESSE061608PV	33	600	1600	800
AESSE062008PV	42	600	2000	800
AESSE062208PV	47	600	2200	800
AESSE081206PV	24	800	1200	600
AESSE081606PV	33	800	1600	600
AESSE082006PV	42	800	2000	600
AESSE082206PV	47	800	2200	600
AESSE081208PV	24	800	1200	800
AESSE081608PV	33	800	1600	800
AESSE082008PV	42	800	2000	800
AESSE082208PV	47	800	2200	800

Note: Further dimensions available on request.

For a cabinet supplied with plinth H=100 (instead of levelling feet), please add Z to the code. (i.e. AESSE061206PVZ).



CUSTOM VERSION ASSEMBLED OR FLAT-PACK CABINET

Composition to be assembled according to the application and specific user's requirements.

Available in both assembled or flat-pack version.

- Removable roof and open bottom.
- Glazed door (single or double) manufactured from sheet steel with tempered glass, supplied with lever-operated double bar locking system with key lock insert and two locking points, supplied with nr. 2 structural uprights manufactured from high-strength low-alloy sheet steel (HSLA).
- Blank door (single or double) manufactured from sheet steel, supplied with lever-operated double bar locking system with key lock insert and two locking points, supplied with nr. 2 structural uprights manufactured from high-strength low-alloy sheet steel (HSLA).
- Ventilated door (single or double) manufactured from sheet steel, supplied with lever-operated double bar locking system with key lock insert and two locking points, supplied with nr. 2 structural uprights manufactured from high-strength low-alloy sheet steel (HSLA).
- Removable panel with quarter turns locking system, supplied with nr. 2 structural uprights manufactured from high-strength low-alloy sheet steel (HSLA).
- Removable side panels (2pcs) with quarter turns locking system.

CODE			DIMENSIONS (MM)	
FLAT-PACK	ASSEMBLED		WIDTH	DEPTH
ABACUS ESSE CABINET - TOP AND BOTTOM				
AETF060060	AETF060060M	---	600	600
AETF060080	AETF060080M	---	600	800
AETF080060	AETF080060M	---	800	600
AETF080080	AETF080080M	---	800	800

CODE		HE	DIMENSIONS (MM)	
FLAT-PACK	ASSEMBLED		WIDTH	HEIGHT
ABACUS ESSE CABINET - SINGLE GLAZED DOOR WITH TWO STRUCTURAL UPRIGHTS				
AEPV060120	AEPV060120M	24	600	1200
AEPV060160	AEPV060160M	33	600	1600
AEPV060200	AEPV060200M	42	600	2000
AEPV060220	AEPV060220M	47	600	2200
AEPV080120	AEPV080120M	24	800	1200
AEPV080160	AEPV080160M	33	800	1600
AEPV080200	AEPV080200M	42	800	2000
AEPV080220	AEPV080220M	47	800	2200

ABACUS ESSE CABINET - DOUBLE GLAZED DOOR WITH TWO STRUCTURAL UPRIGHTS				
FLAT-PACK	ASSEMBLED	HE	WIDTH	HEIGHT
AEPV060120DP	AEPV060120DPM	24	600	1200
AEPV060160DP	AEPV060160DPM	33	600	1600
AEPV060200DP	AEPV060200DPM	42	600	2000
AEPV060220DP	AEPV060220DPM	47	600	2200
AEPV080120DP	AEPV080120DPM	24	800	1200
AEPV080160DP	AEPV080160DPM	33	800	1600
AEPV080200DP	AEPV080200DPM	42	800	2000
AEPV080220DP	AEPV080220DPM	47	800	2200

ABACUS ESSE CABINET - CABLING RANGE



CODE		HE	DIMENSIONS (MM)	
FLAT-PACK	ASSEMBLED		WIDTH	HEIGHT
ABACUS ESSE CABINET - SINGLE BLANK DOOR WITH TWO STRUCTURAL UPRIGHTS				
AEPO060120	AEPO060120M	24	600	1200
AEPO060160	AEPO060160M	33	600	1600
AEPO060200	AEPO060200M	42	600	2000
AEPO060220	AEPO060220M	47	600	2200
AEPO080120	AEPO080120M	24	800	1200
AEPO080160	AEPO080160M	33	800	1600
AEPO080200	AEPO080200M	42	800	2000
AEPO080220	AEPO080220M	47	800	2200

ABACUS ESSE CABINET - DOUBLE BLANK DOOR WITH TWO STRUCTURAL UPRIGHTS				
AEPO060120DP	AEPO060120DPM	24	600	1200
AEPO060160DP	AEPO060160DPM	33	600	1600
AEPO060200DP	AEPO060200DPM	42	600	2000
AEPO060220DP	AEPO060220DPM	47	600	2200
AEPO080120DP	AEPO080120DPM	24	800	1200
AEPO080160DP	AEPO080160DPM	33	800	1600
AEPO080200DP	AEPO080200DPM	42	800	2000
AEPO080220DP	AEPO080220DPM	47	800	2200

CODE		HE	DIMENSIONS (MM)	
FLAT-PACK	ASSEMBLED		WIDTH	HEIGHT
ABACUS ESSE CABINET - SINGLE VENTILATED DOOR WITH TWO STRUCTURAL UPRIGHTS				
AEPS060120	AEPS060120M	24	600	1200
AEPS060160	AEPS060160M	33	600	1600
AEPS060200	AEPS060200M	42	600	2000
AEPS060220	AEPS060220M	47	600	2200
AEPS080120	AEPS080120M	24	800	1200
AEPS080160	AEPS080160M	33	800	1600
AEPS080200	AEPS080200M	42	800	2000
AEPS080220	AEPS080220M	47	800	2200

ABACUS ESSE CABINET - DOUBLE VENTILATED DOOR WITH TWO STRUCTURAL UPRIGHTS				
AEPS060120DP	AEPS060120DPM	24	600	1200
AEPS060160DP	AEPS060160DPM	33	600	1600
AEPS060200DP	AEPS060200DPM	42	600	2000
AEPS060220DP	AEPS060220DPM	47	600	2200
AEPS080120DP	AEPS080120DPM	24	800	1200
AEPS080160DP	AEPS080160DPM	33	800	1600
AEPS080200DP	AEPS080200DPM	42	800	2000
AEPS080220DP	AEPS080220DPM	47	800	2200

ABACUS ESSE CABINET - PANEL WITH TWO STRUCTURAL UPRIGHTS				
AERE060120	AERE060120M	24	600	1200
AERE060160	AERE060160M	33	600	1600
AERE060200	AERE060200M	42	600	2000
AERE060220	AERE060220M	47	600	2200
AERE080120	AERE080120M	24	800	1200
AERE080160	AERE080160M	33	800	1600
AERE080200	AERE080200M	42	800	2000
AERE080220	AERE080220M	47	800	2200



ESSE

SERVER RANGE

CHARACTERISTICS

The profile used for uprights and crosspieces is unique, manufactured from high-strength low-alloy sheet steel (HSLA), closed with continuous fiber laser welding and free of sharp edges. The frame corners are manufactured with orthogonal joints laser welded to vertical upright rails and horizontal rails for the roof and bottom. Only 8 high resistance screws are necessary to mount the structure, while two position pins allow the easy mounting of the two parts of the joint. Panels are manufactured from sheet steel with rounded folding for higher resistance and aesthetics.

PAINT FINISH

ETA standard epoxy polyester powder coating.

- Colour: RAL 9011 textured finish.

PROTECTION RATING

IP20 complying with EN60529

NEMA 1 complying with NEMA 250



STANDARD VERSION ASSEMBLED CABINET



- structure manufactured from high-strength low-alloy sheet steel (HSLA)
- version with front glazed door manufactured from sheet steel (supplied with tempered glass, lever-operated double bar locking system with key lock insert and two locking points) and removable rear panel with quarter turns locking system
- version with front and rear ventilated door manufactured from sheet steel supplied with lever-operated double bar locking system with key lock insert and two locking points
- removable roof with ventilation louvers and cable entry
- removable rear panel with quarter turns locking system
- removable side panels with quarter turns locking system
- nr. 4 front and rear rack profiles
- nr. 4 levelling feet.

CODE	HE	DIMENSIONS (MM)		
		WIDTH	HEIGHT	DEPTH
ABACUS ESSE CABINET - SERVER RANGE WITH GLAZED DOOR				
AESSE061210PVN	24	600	1200	1000
AESSE062010PVN	42	600	2000	1000
AESSE062210PVN	47	600	2200	1000
AESSE061212PVN	24	600	1200	1200
AESSE062012PVN	42	600	2000	1200
AESSE062212PVN	47	600	2200	1200
AESSE081210PVN	24	800	1200	1000
AESSE082010PVN	42	800	2000	1000
AESSE082210PVN	47	800	2200	1000
AESSE081212PVN	24	800	1200	1200
AESSE082012PVN	42	800	2000	1200
AESSE082212PVN	47	800	2200	1200

ABACUS ESSE CABINET - SERVER RANGE WITH VENTILATED DOOR				
AESSE061210PSN	24	600	1200	1000
AESSE062010PSN	42	600	2000	1000
AESSE062210PSN	47	600	2200	1000
AESSE061212PSN	24	600	1200	1200
AESSE062012PSN	42	600	2000	1200
AESSE062212PSN	47	600	2200	1200
AESSE081210PSN	24	800	1200	1000
AESSE082010PSN	42	800	2000	1000
AESSE082210PSN	47	800	2200	1000
AESSE081212PSN	24	800	1200	1200
AESSE082012PSN	42	800	2000	1200
AESSE082212PSN	47	800	2200	1200

Note: Further dimensions available on request.

For a cabinet supplied with plinth H=100 (instead of levelling feet), please add Z to the code. (i.e. AESSE061206PSNZ, AESSE061206PVNZ).



CUSTOM VERSION ASSEMBLED OR FLAT-PACK CABINET

Composition to be assembled according to the application and specific user's requirements.

Available in both assembled or flat-pack version.

- Removable roof and open bottom.
- Glazed door (single or double) manufactured from sheet steel with tempered glass, supplied with lever-operated double bar locking system with key lock insert and two locking points, supplied with nr. 2 structural uprights manufactured from high-strength low-alloy sheet steel (HSLA).
- Blank door (single or double) manufactured from sheet steel, supplied with lever-operated double bar locking system with key lock insert and two locking points, supplied with nr. 2 structural uprights manufactured from high-strength low-alloy sheet steel (HSLA).
- Ventilated door (single or double) manufactured from sheet steel, supplied with lever-operated double bar locking system with key lock insert and two locking points, supplied with nr. 2 structural uprights manufactured from high-strength low-alloy sheet steel (HSLA).
- Removable panel with quarter turns locking system, supplied with nr. 2 structural uprights manufactured from high-strength low-alloy sheet steel (HSLA).
- Removable side panels (2pcs) with quarter turns locking system.

CODE			DIMENSIONS (MM)	
FLAT-PACK	ASSEMBLED		WIDTH	DEPTH
ABACUS ESSE CABINET - TOP AND BOTTOM				
AETF060100N	AETF060100NM	---	600	1000
AETF060120N	AETF060120NM	---	600	1200
AETF080100N	AETF080100NM	---	800	1000
AETF080120N	AETF080120NM	---	800	1200

CODE		HE	DIMENSIONS (MM)	
FLAT-PACK	ASSEMBLED		WIDTH	HEIGHT
ABACUS ESSE CABINET - SINGLE VENTILATED DOOR WITH TWO STRUCTURAL UPRIGHTS				
AEPS060120N	AEPS060120NM	24	600	1200
AEPS060200N	AEPS060200NM	42	600	2000
AEPS060220N	AEPS060220NM	47	600	2200
AEPS080120N	AEPS080120NM	24	800	1200
AEPS080200N	AEPS080200NM	42	800	2000
AEPS080220N	AEPS080220NM	47	800	2200

CODE			DIMENSIONS (MM)	
FLAT-PACK	ASSEMBLED		WIDTH	HEIGHT
ABACUS ESSE CABINET - DOUBLE VENTILATED DOOR WITH TWO STRUCTURAL UPRIGHTS				
AEPS060120DPN	AEPS060120DPNM	24	600	1200
AEPS060200DPN	AEPS060200DPNM	42	600	2000
AEPS060220DPN	AEPS060220DPNM	47	600	2200
AEPS080120DPN	AEPS080120DPNM	24	800	1200
AEPS080200DPN	AEPS080200DPNM	42	800	2000
AEPS080220DPN	AEPS080220DPNM	47	800	2200

CODE		HE	DIMENSIONS (MM)	
FLAT-PACK	ASSEMBLED		WIDTH	HEIGHT
ABACUS ESSE CABINET - SINGLE GLAZED DOOR WITH TWO STRUCTURAL UPRIGHTS				
AEPV060120N	AEPV060120NM	24	600	1200
AEPV060200N	AEPV060200NM	42	600	2000
AEPV060220N	AEPV060220NM	47	600	2200
AEPV080120N	AEPV080120NM	24	800	1200
AEPV080200N	AEPV080200NM	42	800	2000
AEPV080220N	AEPV080220NM	47	800	2200

ABACUS ESSE CABINET - DOUBLE GLAZED DOOR WITH TWO STRUCTURAL UPRIGHTS				
AEPV060120DPN	AEPV060120DPNM	24	600	1200
AEPV060200DPN	AEPV060200DPNM	42	600	2000
AEPV060220DPN	AEPV060220DPNM	47	600	2200
AEPV080120DPN	AEPV080120DPNM	24	800	1200
AEPV080200DPN	AEPV080200DPNM	42	800	2000
AEPV080220DPN	AEPV080220DPNM	47	800	2200

CODE		HE	DIMENSIONS (MM)	
FLAT-PACK	ASSEMBLED		WIDTH	HEIGHT
ABACUS ESSE CABINET - SINGLE BLANK DOOR WITH TWO STRUCTURAL UPRIGHTS				
AEP0060120N	AEP0060120NM	24	600	1200
AEP0060200N	AEP0060200NM	42	600	2000
AEP0060220N	AEP0060220NM	47	600	2200
AEP0080120N	AEP0080120NM	24	800	1200
AEP0080200N	AEP0080200NM	42	800	2000
AEP0080220N	AEP0080220NM	47	800	2200

ABACUS ESSE CABINET - DOUBLE BLANK DOOR WITH TWO STRUCTURAL UPRIGHTS				
AEP0060120DPN	AEP0060120DPNM	24	600	1200
AEP0060200DPN	AEP0060200DPNM	42	600	2000
AEP0060220DPN	AEP0060220DPNM	47	600	2200
AEP0080120DPN	AEP0080120DPNM	24	800	1200
AEP0080200DPN	AEP0080200DPNM	42	800	2000
AEP0080220DPN	AEP0080220DPNM	47	800	2200

ABACUS ESSE CABINET - PANEL WITH TWO STRUCTURAL UPRIGHTS				
AERE060120N	AERE060120NM	24	600	1200
AERE060200N	AERE060200NM	42	600	2000
AERE060220N	AERE060220NM	47	600	2200
AERE080120N	AERE080120NM	24	800	1200
AERE080200N	AERE080200NM	42	800	2000
AERE080220N	AERE080220NM	47	800	2200



ESSE

CHOOSE YOUR SOLUTION

Composition to be assembled according to the application and specific user's requirements.
Available in both assembled or flat-pack version.

- 1 Choose the assembled or flat-pack option
- 2 Identify width and depth
- 3 Select the configuration
- 4 Select the number of HE
- 5 Complete your configuration with the accessories



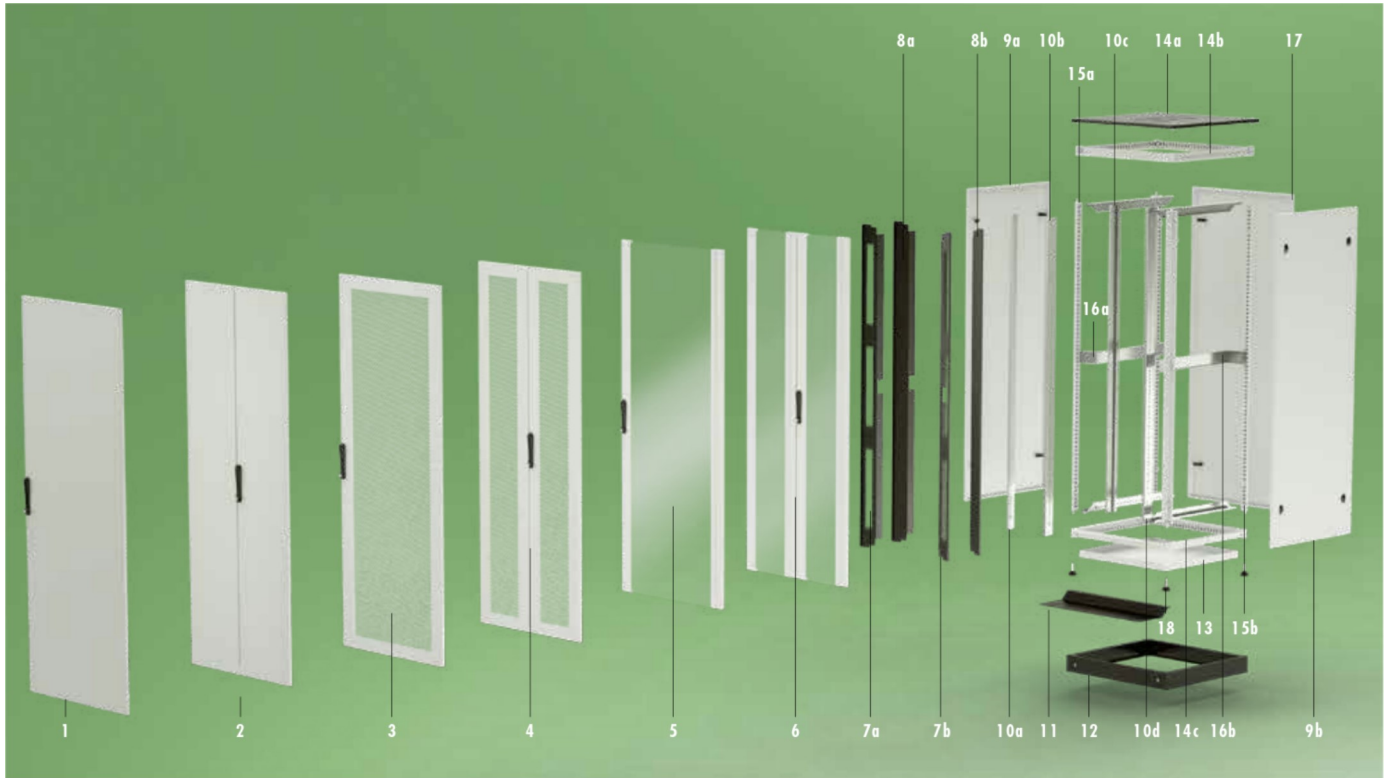

- 1. Single blank door AEPO / APPO
- 2. Double blank door AEPO-DP / APPO-DP
- 3. Single ventilated door AEPS
- 4. Double ventilated door AEPS-DP
- 5. Single glazed door AEPV / APPV
- 6. Double glazed door AEPV-DP

- 7. Multi-function closing strip
- 8. Blank closing strip
- 9. Side panels AEFI / APFI
- 10. Rack uprights AEMK / AERL
- 11. Anti-tilt safety device
- 12. Modular plinth APZE

- 13. Pre-punched bottom for cable-entry
- 14. Top and bottom AETF / APTF
- 15a. 2 structural upright supplied with door
- 15b. 2 structural upright supplied with panel
- 16. Kit 19" with central fixing
- 17. Rear panel AERE / APRE

- 18. Levelling feet AEPX-001



ABACUS ESSE BOX

TECHNICAL FEATURES

Enclosure supplied with glazed door, with removable side panels and complete with nr. 4 adjustable rack profiles (front and rear). Top and bottom with openings for cable entry and ventilation (suitable for fans assembly).

PAINT FINISH

Colour: RAL 9004

SUPPLY

- Enclosure
- Glazed door supplied with tempered glass 5mm thick and locking system with key
- Nr. 4 L-shaped rack profiles
- Cable entry plates for top and bottom.



PROTECTION RATING

IP 20 complying with EN60529.

ABACUS ESSE BOX			
CODE	HE	DIMENSIONS (MM)	
		WIDTH	DEPTH
AESSE6645B	6	600	450
AESSE6945B	9	600	450
AESSE61245B	12	600	450
AESSE61545B	15	600	450
AESSE6660B	6	600	600
AESSE6960B	9	600	600
AESSE61260B	12	600	600
AESSE61560B	15	600	600

Note: further dimensions available on request.



BLANK PANEL
Colour: RAL 9011.

BLANK PANEL		
CODE	HE	MATERIAL
AEP0010	1	MILD STEEL
AEP0011	2	MILD STEEL
AEP0012	3	MILD STEEL
AEP0013	1	PLASTIC, FAST-ASSEMBLY



PANEL WITH NR. 5 CABLE
GUIDE RINGS
Colour: RAL 9011.

PANEL WITH CABLE GUIDE RINGS		
CODE	HE	MATERIAL
AEP0030	1	MILD STEEL
AEP0031	1	PLASTIC
AEP0032	1	WITH BRUSH



PANEL WITH CABLE TRAY
Colour: RAL 9011.

PANEL WITH CABLE TRAY		
CODE	HE	MATERIAL
AEP0020	1	MILD STEEL
AEP0021	1	PLASTIC



CABLE GUIDE RINGS
Manufactured from sheet steel painted RAL9011, with slots on each side to allow the installation in every position.
Supply includes: 10 pieces.

CABLE GUIDE RINGS	
CODE	DIMENSIONS
WTGC-042042	42x42
WTGC-042080	42x80
WTGC-068096	68x96
WTGC-096160	96x160



CABLE ENTRY PANEL WITH
BRUSH
Colour: RAL 9011.

CABLE ENTRY PANEL WITH BRUSH	
CODE	HE
AEP0040	1
AEP0041	2



FIXED SHELF

Load carrying capacity: 30kg
 Colour: RAL9011 textured finish.

FIXED SHELF		
CODE	HE	DEPTH
AEP0050	1	300
AEP0051	1	400

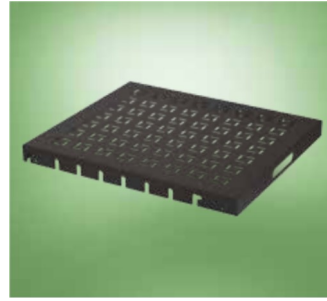

SLIDING SHELF AERI

Sliding shelf with ventilation openings manufactured from sheet steel and fixation on 4 rack rails. Load carrying capacity: 40kg. Paint finish: ETA standard epoxy polyester powder coating. Colour: RAL9011 textured finish. Supply includes: 1 piece with mounting accessories and sliding guides.

SLIDING SHELF AERI		
CODE	CABINET D=mm	SHELF D=mm
AERI000365E	600	365
AERI000465E	600	465
AERI000565E	800	565
AERI000665E	800	665
AERI000765E	1000	765

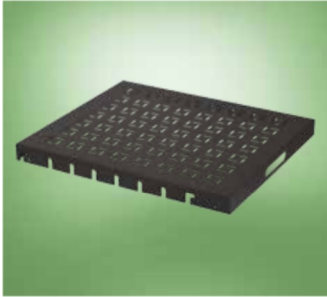

FIXED SHELF AERI

Fixed shelf with ventilation openings manufactured from sheet steel and fixation on 4 rack rails. Load carrying capacity: 70kg. Paint finish: ETA standard epoxy polyester powder coating. Colour: RAL9011 textured finish. Supply includes: 1 piece with mounting accessories.

FIXED SHELF AERI		
CODE	CABINET D=mm	SHELF D=mm
AERI000365	600	365
AERI000465	600	465
AERI000565	800	565
AERI000665	800	665
AERI000765	1000	765



EXTRACTABLE SHELF WITH ROTARY SUPPORT AERI000500M

Extractable shelf D=565mm and rotary support, with mouse area. Paint finish: ETA standard epoxy polyester powder coating. Colour: RAL9011 textured finish. Supply includes: 1 piece with mounting accessories.



WHEELS AERU-001
 High-quality polyamide wheels
 Load capacity: 80kg/wheel
 Supply includes: 4 pieces
 (2 wheels with brake and 2 rotating wheels)



LEVELLING FEET AEPX-001
 Manufactured from PVC, with screws made from zinc steel.
 Supply includes: 4 pieces with mounting accessories



ANTI-TILT SAFETY DEVICE

ANTI-TILT SAFETY DEVICE	
CODE	WIDTH
AEP0060	600
AEP0061	800



19" RAILS AEMK
 Manufactured from zinc sheet steel.
 Supply includes: 2 pieces.

19" RAILS	
CODE	HE
AEMK241200	24
AEMK331600	33
AEMK422000	42
AEMK472200	47

Note: for mounting accessories see page 32.



"L-SHAPED" 19" RAILS AERL
 Manufactured from zinc sheet steel.
 Supply includes: 2 pieces.

"L-SHAPED" 19" RAILS	
CODE	HE
AERL241200	24
AERL331600	33
AERL422000	42
AERL472200	47

Note: for mounting accessories see page 32.



DEPTH RAILS

Rails for the mounting of 19" rack uprights on cabinets W=800mm. Manufactured from sendzimir sheet steel. Supply includes: nr. 4 pieces

RAILS	
CODE	DEPTH
AEP0094	600
AEP0095	800
AEP0096	1000
AEP0097	1200



19" CENTRAL REINFORCING BRACKETS

Manufactured from zinc sheet steel. Supply includes 2 pieces.

KIT 19" WITH CENTRAL FIXING	
CODE	DEPTH
AEP0084	600
AEP0085	800
AEP0086	1000
AEP0087	1200



BRACKETS AEP0070

Brackets manufactured from zinc sheet steel, used for the mounting of 19" uprights on cabinets W=600mm. Supply includes: nr. 4 pieces



PRE-PUNCHED BOTTOM FOR CABLE-ENTRY

Manufactured from mild steel painted RAL 7035.

PRE-PUNCHED BOTTOM FOR CABLE-ENTRY		
CODE	WIDTH	DEPTH
AEP0072	600	600
AEP0073	600	800
AEP0074	600	1000
AEP0075	600	1200
AEP0076	800	600
AEP0077	800	800
AEP0078	800	1000
AEP0079	800	1200

Note: for pre-punched bottom for cable-entry colour RAL 9011
 – available for W=600/800mm x
 D=1000/1200mm – please add N to the code (i.e. AEP0074N).

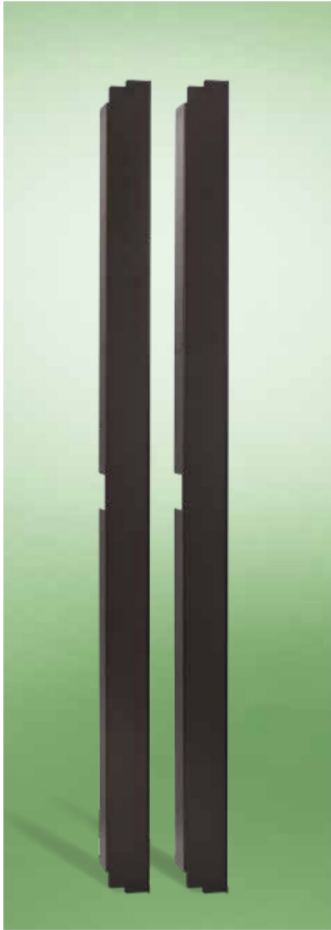

BLANK CLOSING TRIM PANELS

Used to divide the cold and hot airflow inside the cabinet.
 Colour: RAL 9011 textured finish.
 Supply includes 2 pieces.

BLANK CLOSING TRIM PANELS (2PC)	
CODE	HE
AEP0080	24
AEP0081	33
AEP0082	42
AEP0083	47



MULTI-FUNCTION CLOSING PANELS

Multi-functions panels to be completed with the 19" panels available.
 Colour: RAL 9011 textured finish.
 Supply includes 2 pieces.

MULTI-FUNCTION CLOSING PANELS (2PC)	
CODE	HE
AEP0090	24
AEP0091	33
AEP0092	42
AEP0093	47



SIDE PANELS

Manufactured from sheet steel with quarter turns locking system. Paint finish: ETA standard epoxy polyester powder coating. Colour: RAL7035 textured finish for Cabling application, RAL9011 textured finish for Server application. Supply includes: 2 pieces with mounting accessories.

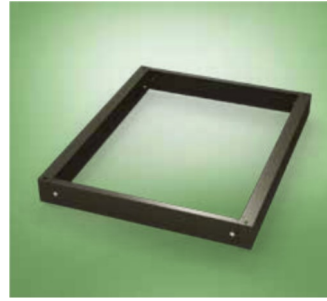

AEZE PLINTH

Front crosspieces and side crosspieces with integrated corners manufactured from sheet steel. Paint finish: ETA standard epoxy polyester powder coating. Colour: RAL9011 textured finish. Supply includes: front crosspieces (nr. 2 pieces) and side crosspieces with integrated corners (nr. 2 pieces).

ABACUS ESSE CABINET - SIDE PANELS					
FLAT-PACK	CODE		HE	DIMENSIONS (MM)	
	ASSEMBLED			DEPTH	HEIGHT
AEFI060120	AEFI060120M		24	600	1200
AEFI060160	AEFI060160M		33	600	1600
AEFI060200	AEFI060200M		42	600	2000
AEFI060220	AEFI060220M		47	600	2200
AEFI080120	AEFI080120M		24	800	1200
AEFI080160	AEFI080160M		33	800	1600
AEFI080200	AEFI080200M		42	800	2000
AEFI080220	AEFI080220M		47	800	2200
AEFI100120	AEFI100120M		24	1000	1200
AEFI100200	AEFI100200M		42	1000	2000
AEFI100220	AEFI100220M		47	1000	2200
AEFI120120	AEFI120120M		24	1200	1200
AEFI120200	AEFI120200M		42	1200	2000
AEFI120220	AEFI120220M		47	1200	2200

Note: Further dimensions available on request.

For side panel ESSE server range (colour RAL 9011) - available from dimensions H=1200 x D=1000 - please add N to the code (i.e. AEFI100120N, AEFI100120NM).

ABACUS CABINET - PLINTH WITH INTEGRATED CORNERS				
FLAT-PACK	CODE		DESCRIPTION	DIMENSIONS (MM)
	ASSEMBLED			
AEZE-T0600F	AEZE-T0600FM		FRONT CROSSPIECES (2PCS) H=100	600
AEZE-T0800F	AEZE-T0800FM		FRONT CROSSPIECES (2PCS) H=100	800
AEZE-T0600L	AEZE-T0600LM		SIDE CROSSPIECES WITH INTEGRATED CORNERS (2PCS) H=100	600
AEZE-T0800L	AEZE-T0800LM		SIDE CROSSPIECES WITH INTEGRATED CORNERS (2PCS) H=100	800
AEZE-T1000L	AEZE-T1000LM		SIDE CROSSPIECES WITH INTEGRATED CORNERS (2PCS) H=100	1000
AEZE-T1200L	AEZE-T1200LM		SIDE CROSSPIECES WITH INTEGRATED CORNERS (2PCS) H=100	1200



SIDE PANELS

Manufactured from sheet steel with rounded folding for easy handling. Assembled with screws.
 Paint finish: ETA standard epoxy polyester powder coating.
 Colour: RAL7035 textured finish.
 Supply includes: 2 pieces with mounting accessories.



MODULAR PLINTH APZE

Modular plinth consisting of corner pieces and side/front crosspieces manufactured from sheet steel.
 Paint finish: ETA standard epoxy polyester powder coating.
 Colour: RAL9011 textured finish.
 Supply includes: corner pieces (4 pieces with PVC front cover caps and mounting accessories), front crosspieces (2 pieces) and side crosspieces (2 pieces).

ABACUS PRO CABINET - SIDE PANELS					
FLAT-PACK	CODE		HE	DIMENSIONS (MM)	
		ASSEMBLED		DEPTH	HEIGHT
APFI060120		APFI060120M	24	600	1200
APFI060160		APFI060160M	33	600	1600
APFI060200		APFI060200M	42	600	2000
APFI060220		APFI060220M	47	600	2200
APFI080120		APFI080120M	24	800	1200
APFI080160		APFI080160M	33	800	1600
APFI080200		APFI080200M	42	800	2000
APFI080220		APFI080220M	47	800	2200
APFI100120		APFI100120M	24	1000	1200
APFI100160		APFI100160M	33	1000	1600
APFI100200		APFI100200M	42	1000	2000
APFI100220		APFI100220M	47	1000	2200
APFI120120		APFI120120M	24	1200	1200
APFI120160		APFI120160M	33	1200	1600
APFI120200		APFI120200M	42	1200	2000
APFI120220		APFI120220M	47	1200	2200

ABACUS CABINET - MODULAR PLINTH			
FLAT-PACK	CODE		DIMENSIONS (MM)
		ASSEMBLED	
APZE-A100		APZE-A100M	CORNER PIECES (4PCS) H=100
APZE-A200		APZE-A200M	CORNER PIECES (4PCS) H=200
APZE-T0600		APZE-T0600M	CROSSPIECES (2PCS)
APZE-T0800		APZE-T0800M	CROSSPIECES (2PCS)
APZE-T1000		APZE-T1000M	CROSSPIECES (2PCS)
APZE-T1200		APZE-T1200M	CROSSPIECES (2PCS)

Note: To order the plinth H=200, please add D to the code (i.e. APZE-T0600D)
 To order the ventilated plinth please add S to the code, (i.e. APZE-T0600S).



JOINING KIT AEKU-005
Simplified solution of joining kit manufactured from thick pressed zincpassivated sheet steel.
Supply includes: 4 pieces.



CAGE NUTS M8 WTDA-001
Supply includes: 20 pieces.



CAGE NUTS M6 WTDA-002
Supply includes: 20 pieces.



EYEBOLTS WTGS-001
M12 eyebolts manufactured from zincpassivated sheet steel.
Supply includes: 4 pieces .

BRUSH

BRUSH	
CODE	DIMENSION MM
AEP0100	600
AEP0101	800



SCREWS AND CAGE NUTS M6
M6x16 screws.
Supply includes:
WA109 - 20 cage nuts and 20 screws
WA110 - 50 cage nuts and 50 screws
WA111 - 20 cage nuts, 20 screws and 20 plastic under-screw-edge.



KIT FOR EASY HE IDENTIFICATION – AEP0110
Self-adhesive blank strip to be stuck on L-shaped rails or 19" rails.
L=47HE.



HANDLES

Further to ETA standard locking system, ETA offers a wide range of handles with key-lock insert, pad-locking option, push-button release or special inserts. Available upon request.



PLAN POCKET WA050

A4 sheet size plan pocket manufactured from thermoplastic material. Supply includes: 1 piece with double-sided adhesive tape.

LOCKING SYSTEMS		
CODE		DESCRIPTION
WE520	⊙	INSERT Ø 3 MM
WE522		KEY Ø 3 MM
WE530		INSERT Ø 5 MM
WE532		KEY Ø 5 MM
WE540	□	INSERT \sphericalangle 7 MM
WE542		KEY \sphericalangle 7 MM
WE550	△	INSERT \sphericalangle 7 MM
WE552		KEY \sphericalangle 7 MM
WE560		INSERT \sphericalangle 8 MM
WE562		KEY \sphericalangle 8 MM
WE570	⊙	FIAT INSERT
WE572		FIAT KEY

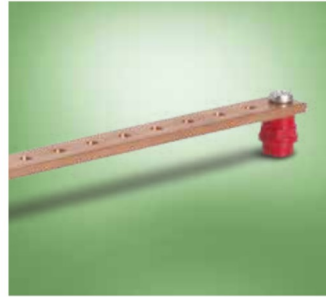

EARTHING

COPPER BAR – AEPO120

Equipotential copper bar for ground connectors (with isolators) that can be installed along the depth or the width of ABACUS cabinets. Manufactured from 20x5mm copper bars, with M6 threaded holes.



GROUNDING CABLES – AEPO121

Yellow/green grounding cables section 6mm², length 150mm, complete with ring lugs Ø5mm. Supply includes: nr. 10 pieces



LAMPS WTLA

The fluorescent lamps are characterized with electronic circuits that both increase the luminous emission and eliminate the stroboscopic effect of the traditional neon lamps. The electronic lamps WTLA last more than the neon and incandescent ones, so they are more efficient, convenient and energy savers.

Up to 5 lamps can be mounted on a single cabinet.

CHARACTERISTICS

Casing in aluminium finishing, diffuser in methacrylate with switch. Supply includes: 1 piece with adjustable fixing brackets, mounting accessories and a bipolar connector for the wiring.



Protection rating: IP20.

CODE	LAMPS			
	V	Hz	W	LENGHT
WTLA-050	220:240	50:60	8	342
WTLA-060	220:240	50:60	13	574
WTLA-065	110:130	60	13	574
WTLA-070	220:240	50:60	21	905



ENERGY BOX AEP0600

Enclosure manufactured from mild steel designed for the assembly of components and modular equipments. Consisting of a fixed part including DIN rail and a shell with adjustable opening.

CHARACTERISTICS

Suitable for nr. 4 pre-punched cable entry.
Box dimensions: height 3HE.
Colour: RAL7035



ROOF VENTILATION UNIT

- Roof ventilation unit with available space for 2 fans
- Roof ventilation unit with available space for 4 fans
- Roof ventilation unit with available space for 6 fans.

ROOF VENTILATION UNIT		
CODE	NR. FANS	THERMOSTAT
AEP0251	2	NO
AEP0252	4	NO
AEP0253	6	NO
AEP0254	2	YES
AEP0255	4	YES
AEP0256	6	YES



AXIAL FAN – AEP0249

Supplied with grid and cable.
Dimensions 120x120x38mm
Flow: 97/117 CFM

LOW-NOISE FAN – AEP0250

Dimensions: 120x120x38mm
Flow: 72/78CFM
Noise level: 37/39dB(A)



THE PANEL WITH DIGITAL THERMOSTAT – AEP0257

COMPLETE RANGE OF PDU

CHARACTERISTICS

- Strong structure manufactured from aluminium
- Height 1 HE
- Depth-adjustable 19" fixing brackets
- To be mounted on rack profiles or on cabinet structure
- Multistandard output (Schuko + Italian 10/16Amp) with angle 45°
- Output IEC320-C13 e IEC320-C19
- Protection, management and control devices protected by wrong operation

- Cable L=3mt H05VV-F3Gcx1, 5mmq
- Temperature limit up to 60°C
- Paint finish: epoxy polyester powder coating. Colour: RAL 9004

Available on request:

- Output according to different markets
- Different cables and input



19" PDU					
CODE	OUTPUT	ASSEMBLY	A	WATT	DETAILS
AEP0520	9 multistandard	19" internal	16	3500	
AEP0521	8 multistandard	19" internal	16	3500	switch indicator lamp
AEP0522	6 multistandard	19" internal	16	3500	thermal magnetic switch lamp bip16A
AEP0523	13 multistandard	internal	16	3500	-
AEP0524	13 multistandard	internal	16	3500	switch indicator lamp
AEP0525	12 multistandard	internal	16	3500	thermal magnetic switch lamp bip16A
AEP0526	9 IEC-C13	19" internal	10	2500	switch indicator lamp
AEP0527	8 IEC-C19	19" internal	16	3500	
AEP0528	8 multistandard	19" internal	16	3500	ammeter
AEP0529	8 IEC-C13	19" internal	10	2500	ammeter
AEP0530	8 IEC-C19	19" internal	16	3500	ammeter
AEP0531	5 multistandard	19" internal	16	3500	switch indicator lamp and multistandard pdu controlled with thermostat



CHARACTERISTICS

- Strong structure manufactured from aluminium
- Vertical mounting
- 1-phase or 3-phase up to 16/32Amp
- Output IEC320-C13 e IEC320-C19
- Protection, management and control devices protected by wrong operation
- Cable 1-phase or 3-phase L=5mt H05VV with output IEC60309
- Temperature limit up to 60°C
- Paint finish: epoxy polyester powder coating. Colour: RAL 9004

Available on request:

- Output according to different markets
- Different cables and input



VERTICAL PDU						
CODE	OUTPUT		INPUT	THERMAL MAGNETIC SWITCH	DISPLAY	L. (mm)
	C13	C19				
AEP0540	16	6	1-Phase 230 Vac 16A	Bipolar 16A	ammeter	1139
AEP0541	16	6	1-Phase 230 Vac 32A	Bipolar 32A	ammeter	1139
AEP0542	24	9	1-Phase 230 Vac 32A	Bipolar 32A	ammeter	1582
AEP0543	21	9	3-Phase 400 Vac 32A	nr. 3 bipolar 32A 1 circuit breaker/phase	nr. 3 ammeter	1850
	7	3				



ABACUS PRO range is the successful result of ETA market analysis and R&D process, and represents the perfect combination between strength and design: suite cabinets with protection rating IP55, wall-mounting boxes, special solutions for harsh environments (stainless steel, EMC, outdoor) and a wide range of accessories. From one stand-alone cabinet to larger applications, ABACUS PRO is the complete system designed to meet your needs.

A B A C U S

SYSTEM

PRO



ABACUS PRO CABINET

CHARACTERISTICS

The profile used for uprights and crosspieces is unique, manufactured from high-strength low-alloy sheet steel (HSLA), closed with continuous fiber laser welding and free of sharp edges. The bottom is a single piece with box-type structure manufactured from press-bent fiber laser-MIG hybrid welded profiles manufactured from high-strength low-alloy sheet steel (HSLA). The frame corners are manufactured with orthogonal joints laser welded to vertical upright rails and horizontal rails for the roof and bottom. Only 8 high resistance screws are necessary to mount the structure, while two position pins allow the easy mounting of the two parts of the joint. Panels are manufactured from sheet steel with rounded folding for higher resistance.



ABACUS PRO CABINET

PAINT FINISH

ETA standard epoxy polyester powder coating.

- Structure: RAL 7035 smooth finish.
- Door and rear panel: RAL 7035 textured finish.
- Roof: RAL 9011 textured finish.

PROTECTION RATING

- IP55 complying with EN60529.
- Nema 12 complying with NEMA250.
- Protection degree guaranteed by the two component polyurethane foam seal.
- Impact resistance IK10 complying with EN62262.





STANDARD VERSION ASSEMBLED CABINET

Choose your standard solution supplied
already assembled

- Structure manufactured from high-strength low-alloy sheet steel (HSLA)
- Reversible blank or glazed door manufactured from sheet steel with stiffening frame, supplied with double-bar lever-operated locking system, 4 locking points and 4 hinges
- Locking system with a unique lever mechanism, unique design and:
 - 3-point locking for H=1400 and 1600
 - 4-point locking for H=1800 and 2000
 - 5-point locking for H=2200
 with possibility to mount different inserts and convenient lock release system of the slave door of the double door cabinet
- Reversible door with stiffening frame
- Sturdy panels for high structural stiffness
- Modular cable entry bottom with adjustable base plates and seal, consisting of one fiber laser-MIG hybrid welded piece with box-type construction manufactured from high-strength low-alloy steel
- Removable roof panel
- Screwed rear panel
- Nr. 2 front rack profiles.

CODE		HE	DIMENSIONS (MM)		
GLAZED DOOR	BLANK DOOR		WIDTH	HEIGHT	DEPTH
ABACUS PRO CABINET					
APR0061206PV	APR0061206PR	24	600	1200	600
APR0061606PV	APR0061606PR	33	600	1600	600
APR0061806PV	APR0061806PR	38	600	1800	600
APR0062006PV	APR0062006PR	42	600	2000	600
APR0062206PV	APR0062206PR	47	600	2200	600
APR0061208PV	APR0061208PR	24	600	1200	800
APR0061608PV	APR0061608PR	33	600	1600	800
APR0061808PV	APR0061808PR	38	600	1800	600
APR0062008PV	APR0062008PR	42	600	2000	800
APR0062208PV	APR0062208PR	47	600	2200	800
APR0061210PV	APR0061210PR	24	600	1200	1000
APR0061610PV	APR0061610PR	33	600	1600	1000
APR0061810PV	APR0061810PR	38	600	1800	1000
APR0062010PV	APR0062010PR	42	600	2000	1000
APR0062210PV	APR0062210PR	47	600	2200	1000
APR0062012PV	APR0062012PR	42	600	2000	1200
APR0062212PV	APR0062212PR	47	600	2200	1200
APR0081206PV	APR0081206PR	24	800	1200	600
APR0081606PV	APR0081606PR	33	800	1600	600
APR0081806PV	APR0081806PR	38	800	1800	600
APR0082006PV	APR0082006PR	42	800	2000	600
APR0082206PV	APR0082206PR	47	800	2200	600
APR0081208PV	APR0081208PR	24	800	1200	800
APR0081608PV	APR0081608PR	33	800	1600	800
APR0081808PV	APR0081808PR	38	800	1800	800
APR0082008PV	APR0082008PR	42	800	2000	800
APR0082208PV	APR0082208PR	47	800	2200	800
APR0081210PV	APR0081210PR	24	800	1200	1000
APR0081610PV	APR0081610PR	33	800	1600	1000
APR0081810PV	APR0081810PR	38	800	1800	1000
APR0082010PV	APR0082010PR	42	800	2000	1000
APR0082210PV	APR0082210PR	47	800	2200	1000
APR0082012PV	APR0082012PR	42	800	2000	1200
APR0082212PV	APR0082212PR	47	800	2200	1200

Note: Further dimensions available on request
Side panels APFI to be ordered separately (see page 35)

ABACUS PRO CABINET





CUSTOM VERSION ASSEMBLED OR FLAT-PACK CABINET

Composition to be assembled according to the application and specific user's requirements.

Available in both assembled or flat-pack version.

- Removable roof and bottom supplied with adjustable cable entry
- Reversible glazed door manufactured from sheet steel and tempered glass, provided with stiffening frame and double-bar lever-operated locking system, supplied with nr. 2 structural uprights manufactured from high-strength low-alloy sheet steel (HSLA)
- Reversible blank door manufactured from sheet steel, provided with stiffening frame and double-bar lever-operated locking system, supplied with nr. 2 structural uprights manufactured from high-strength low-alloy sheet steel (HSLA)
- Locking system with a unique lever mechanism, unique design and:
 - 3-point locking for H=1400 and 1600
 - 4-point locking for H=1800 and 2000
 - 5-point locking for H=2200
 with possibility to mount different inserts and convenient lock release system of the slave door of the double door cabinet
- Nr. 2 side panels
- Sturdy panels for high structural stiffness
- Modular cable entry bottom with adjustable base plates and seal, consisting of one fiber laser-MIG hybrid welded piece with box-type construction manufactured from high-strength low-alloy steel
- Removable roof panel

- Screwed rear panel with nr. 2 structural uprights manufactured from high-strength low-alloy sheet steel (HSLA)
- Nr. 2 front rack profiles.

CODE			DIMENSIONS (MM)	
FLAT-PACK	ASSEMBLED		WIDTH	DEPTH
ABACUS PRO CABINET - TOP AND BOTTOM				
APTF060060	APTF060060M	---	600	600
APTF060080	APTF060080M	---	600	800
APTF060100	APTF060100M	---	600	1000
APTF060120	APTF060120M	---	600	1200
APTF080060	APTF080060M	---	800	600
APTF080080	APTF080080M	---	800	800
APTF080100	APTF080100M	---	800	1000
APTF080120	APTF080120M	---	800	1200

CODE		HE	DIMENSIONS (MM)	
FLAT-PACK	ASSEMBLED		WIDTH	HEIGHT
ABACUS PRO CABINET - SINGLE BLANK DOOR WITH TWO STRUCTURAL UPRIGHTS				
APP0060120	APP0060120M	24	600	1200
APP0060160	APP0060160M	33	600	1600
APP0060180	APP0060180M	38	600	1800
APP0060200	APP0060200M	42	600	2000
APP0060220	APP0060220M	47	600	2200
APP0080120	APP0080120M	24	800	1200
APP0080160	APP0080160M	33	800	1600
APP0080180	APP0080180M	38	800	1800
APP0080200	APP0080200M	42	800	2000
APP0080220	APP0080220M	47	800	2200

CODE		HE	DIMENSIONS (MM)	
FLAT-PACK	ASSEMBLED		WIDTH	HEIGHT
ABACUS PRO CABINET - SINGLE GLAZED DOOR WITH TWO STRUCTURAL UPRIGHTS				
APPV060120	APPV060120M	24	600	1200
APPV060160	APPV060160M	33	600	1600
APPV060180	APPV060180M	38	600	1800
APPV060200	APPV060200M	42	600	2000
APPV060220	APPV060220M	47	600	2200
APPV080120	APPV080120M	24	800	1200
APPV080160	APPV080160M	33	800	1600
APPV080180	APPV080180M	38	800	1800
APPV080200	APPV080200M	42	800	2000
APPV080220	APPV080220M	47	800	2200

Note: Double glazed door available on request.

ABACUS PRO CABINET - DOUBLE BLANK DOOR WITH TWO STRUCTURAL UPRIGHTS				
APPO060120DP	APPO060120DPM	24	600	1200
APPO060160DP	APPO060160DPM	33	600	1600
APPO060180DP	APPO060180DPM	38	600	1800
APPO060200DP	APPO060200DPM	42	600	2000
APPO060220DP	APPO060220DPM	47	600	2200
APPO080120DP	APPO080120DPM	24	800	1200
APPO080180DP	APPO080180DPM	33	800	1800
APPO080160DP	APPO080160DPM	38	800	1600
APPO080200DP	APPO080200DPM	42	800	2000
APPO080220DP	APPO080220DPM	47	800	2200

CODE		HE	DIMENSIONS (MM)	
FLAT-PACK	ASSEMBLED		WIDTH	HEIGHT
ABACUS PRO CABINET - PANEL WITH TWO STRUCTURAL UPRIGHTS				
APRE060120	APRE060120M	24	600	1200
APRE060160	APRE060160M	33	600	1600
APRE060180	APRE060180M	38	600	1800
APRE060200	APRE060200M	42	600	2000
APRE060220	APRE060220M	47	600	2200
APRE080120	APRE080120M	24	800	1200
APRE080160	APRE080160M	33	800	1600
APRE080180	APRE080180M	38	800	1800
APRE080200	APRE080200M	42	800	2000
APRE080220	APRE080220M	47	800	2200



AIR-CONDITIONED OPERATING CABINET

If specific environments or properly air-conditioned data center are not available for your application, the temperature developed from the server installed inside the rack might be so high that a proper cooling is required.

So, the air-conditioned operating cabinet is the most proper solution to solve the problems of heat dissipation: the protection rating IP55 of ABACUS PRO guarantees the best working conditions for the air conditioner - available from 400W to 4000W of cooling capacity and in both wall-mounting and roof-mounting versions – thus to ensure the optimal cooling of your servers.



WALL-MOUNTING AIR-CONDITIONER WICD

- New design
- New display & electronic system
- Smart Energy Management
- Sequencing (option)
- Modbus (option)
- Best protection for outdoor protection
- Energy saving up to 23% with respect to the previous version
- New assembly to make installation easier
- Working up to -40°
- Test complying with UNI 14511-2
- Protection rating Type 12 – UL available on request
- Colour: RAL 7035 (textured for outdoor version – smooth for indoor version).

CODE	COOLING CAPACITY W	POWER SUPPLY	CERTIFICATIONS
AIR CONDITIONERS FOR WALL AND DOOR MOUNTING			
WICDU3811CW	380	115V-1-60Hz	cRUus
WICDU5811CW	580	115V-1-60Hz	cRUus
WICDU5823CW	580	230V-1-50/60Hz	cRUus
WICDU9011CW	900	115V-1-60Hz	cRUus
WICDU9023CW	900	230V-1-50/60Hz	cRUus
WICDU1611CW	1600	115V-1-60Hz	cRUus
WICDU1623CW	1600	230V-1-50/60Hz	cRUus
WICDU2211CW	2200	115V-1-60Hz	cRUus
WICDU2223CW	2200	230V-1-50/60Hz	cRUus
WICDU3123CW	3150	230V-1-50/60Hz	cRUus
WICDU4123CW	4100	230V-1-50/60Hz	cRUus
WICD3823CW	360-380	230V-1-50/60Hz	---
WICD5823CW	550-580	230V-1-50/60Hz	---
WICD9023CW	850-900	230V-1-50/60Hz	---
WICD1123CW	1100-1150	230V-1-50/60Hz	---
WICD1140CW	1050-1100	400V-2-50/60Hz	---
WICD1623CW	1500-1600	230V-1-50/60Hz	---
WICD1540CW	1400-1500	400V-2-50/60Hz	---
WICD2223CW	2100-2200	230V-1-50/60Hz	---
WICD2140CW	2000-2100	400V-3-50/60Hz	---
WICD3123CW	3000-3150	230V-1-50/60Hz	---
WICD3040CW	2850-3000	400V-3-50/60Hz	---
WICD4123CW	4000-4100	230V-1-50/60Hz	---
WICD4040CW	3950-4050	400V-3-50/60Hz	---

TOP MOUNTING AIR-CONDITIONER WICT

TECHNICAL FEATURES

- Functioning up to +55°C (environment).
- Refrigerant Gas R134a.
- Self cleaning condenser.
- Hydrophilic evaporator.
- Condensate dissipating device from WICT-1423CW model.
- Quick connections (except 330W).
- Digital thermostat ECB (except 330W).
- Sheet cover, painted in RAL 7035 textured finish.
- Protection rating on the cabinet side: IP54.

CODE	COOLING CAPACITY L35L35 DIN3168	POWER SUPPLY V-ph-Hz	CERTIFICATIONS
TOP MOUNTING AIR-CONDITIONER WICT			
WICT3323CW	330 W	230-1-50/60	---
WICT3311CW	330 W	115-1-60	---
WICTU5023CW	600 W	230-1-50/60	cRUus
WICTU5011CW	600 W	115-1-60	cRUus
WICT6023CW	600 W	230-1-50/60	---
WICT6040CW	600 W	400-2-50 460-2-60	---
WICT9023CW	900 W	230-1-50/60	---
WICTU1023CW	900 W	230-1-50/60	cRUus
WICTU1011CW	900 W	115-1-60	cRUus
WICT1423CW	1400 W	230-1-50/60	---
WICTU1423CW*	1400 W	230-1-50/60	cRUus
WICTU1411CW	1400 W	115-1-60	cRUus
WICT1440CW	1400 W	400-2-50 460-2-60	---
WICT2023CW*	2000 W	230-1-50/60	---
WICT2040CW	2000 W	400-2-50 460-2-60	---
WICT2723CW	2700 W	230-1-50/60	---
WICT2740CW	2700 W	400-3-50 460-3-60	---
WICT3823CW	3800 W	230-1-50/60	---
WICTU3823CW	3800 W	230-1-50/60	cRUus
WICT3840CW	3800 W	400-3-50 460-3-60	---
WICT5240CW	5200 W	400-3-50 460-3-60	---

* Item available on stock.

CLICK & FIT FILTERING GRIDS AND FANS

TECHNICAL FEATURES

- Air Flow 37-831 m³/h
- Reversible air flow, push/pull (except WT315B – WT315VB)*
- Easy maintenance and filter substitution

CHARACTERISTICS

Grids and supports manufactured from thermoplastic material:

- heat resistance (-35°C +80°C)
- IEC/DIN 53480 KA 3 sliding currents resistance
- colour similar to RAL 7035
- sealing gasket to guarantee IP54

Filtering panel manufactured from mixed polyester-modacrylic fibres:

- high filtering capacity
- max working temperature 130°C
- easily removed
- good reutilization.

PROTECTION RATING

- IP54
- NEMA 12 complying with UL508A; UL50.

* WT315B and WT315VB available in pull version as standard; for push version, please contact the ETA Sales team.



FILTER GRIDS CLICK & FIT		
CODE	EXTERNAL DIMENSIONS	
WT320B	115	115
WT330B	163	163
WT335B	214	214
WT340B	266	266

REPLACEMENT FILTERING PANELS CLICK & FIT			
CODE	DIMENSIONS		FOR
WT329	82	83	WT320B
WT333	120	120	WT330B / WT300B
WT338	170	170	WT335B / WT305B / WT308B
WT343	235	235	WT340B / WT310B / WT315B

FAN WITH FILTER CLICK & FIT						
CODE	NOMINAL VOLTAGE	POWER	AIR FLOW WITH FILTER	UNHINDERED AIR FLOW	NOISE LEVEL	CERTIFICATIONS
WT	V/Hz	WATT	m ³ /H	m ³ /H	dB(A)	
WT290B	230/50-60	14/13,5	14	37	30	cURus
WT300B	230/50-60	22/21	44	65	45	cURus
WT305B	230/50-60	22/21	97	140	45	cURus
WT308B	230/50-60	36	205	240	52	cURus
WT310B	230/50-60	36	295	345	52	cURus
WT315B	230/50-60	84	485	831	65	-

EXHAUST FAN - TOP MOUNTING INSTALLATION

Available in 4 sizes, air flow: 575-2365 m³/h.

TECHNICAL FEATURES

- radial fans with high external static pressure
- available without fans for applications
- sheet cover, painted in RAL 7035 textured finish
- protection rating: IP44 (IP54 available on request) for ventilation fan
- protection rating: IP22 for aeration fan.

OPTIONAL

- Special RAL colours available
- Cover manufactured from stainless steel AISI304 available on request

EXHAUST FANS					
		WT200CW	WT205CW	WT210CW	WT215CW
VOLTAGE/PHASE/FREQUENCY	V-ph-Hz	230-1-50/60	230-1-50/60	230-1-50/60	230-1-50/60
WIDTH/HEIGHT/DEPTH	MM	460x108x380	460x108x380	540x160x400	600x300x550
FAN FLOW, FREE AIR	M ³ /h	575	860	1450	2365
ABSORBED CURRENT	A	0,34	0,4	0,95	1,1
PROTECTIVE FUSES	A	2	4	4	4
ABSORBED POWER	W	75	85	215	170
TEMPERATURE LIMITS	°C	-20/+55	-20/+55	-20/+55	-20/+55
NOISE LEVEL	dB(A)	80	80	82	82
WEIGHT	kg	5,8	8	12	20
WEIGHT/VOLUME SHIPMENT	kg/m ³	7/0,03	9/0,03	13/0,047	21/0,25

THERMAL MANAGEMENT



TERMOSTAT WITH OPENING/CLOSING CONTACT NC/NO

When the temperature increases there's the contact opening/closing to be used to control air temperature inside cabinet:

- heating
- ventilation
- signal transmissions.

THERMOSTATS	
CODE	POWER WATT
WI282	NC CONTACT OPENING
WI284	NO CONTACT CLOSING



THERMOSTAT WI286

Two thermostats in one casing:

- thermostat (contact breaker, normally closed) for regulation heaters
- thermostat (contact breaker, normally open) for regulation filter fans and heat exchangers or switching signal devices when temperature limit has been exceeded.

TECHNICAL FEATURES

- Adjustment range (NC – NO): 0° ÷ 60°C
- Maximum opening capacity: 250 V AC, 10 (2) A / 120 V AC, 10 (2) A – DC 30 W
- Working life: > 100.000 cycles
- Connections: 2,5 mm², 4 poles
- Fixing: clip fixing on 35 mm DIN rails
- Housing: UL 94 VO thermoplastic material
- Dimensions: 50 x 67 x 46 mm.

PROTECTION RATING

IP20.



HEATING

Element PTC (semiconductor).

PROTECTION CLASS

I (protection wire to earth).

HEATERS						
CODE	POWER WATT	TENSION V AC/DC	DIM.	PROTECTION CLASS	DESCRIPTION	TRADEMARKS
WI271	10	120/240	52	IP44	WITH CABLE	CE VDE ROHS
WI273	20	120/240	60	IP44	WITH CABLE	
WI274	30	120/240	70	IP44	WITH CABLE	
WI250	15	120/240	65	IP20	WITHOUT CABLE	CE VDE CRUUS ROHS
WI255	30	120/240	65	IP20	WITHOUT CABLE	
WI260	45	120/240	65	IP20	WITHOUT CABLE	
WI265	75	120/240	140	IP20	WITHOUT CABLE	
WI270	150	120/240	220	IP20	WITHOUT CABLE	



ABACUS PRO BOX Indoor application

TECHNICAL FEATURES

Enclosure manufactured from sheet steel, supplied with cable entry and blank reversible door, complete with nr. 2 rack profiles mounted on the front. Enclosure suitable for the assembly of both nr. 2 additional rack profiles on the back and the mounting plate. Rack profiles manufactured from galvanized sheet steel.

PAINT FINISH

ETA standard epoxy polyester powder coating.
Enclosure and door: colour RAL 7035 textured finish.

SUPPLY

- Enclosure
- Door provided with locking system with \varnothing 3mm double bar key and 2 zincpassivated rails
- Cable entry plate with sealing gasket
- Nr. 2 rack profiles
- Screws for earth connection and mounting accessories.



PROTECTION RATING

- IP66 complying with EN60529
- NEMA 4 (single door) NEMA 12 (double door) complying with NEMA 250
- protection degree guaranteed by the two component foam seal
- impact resistance IK10 complying with EN62262.



CODE	HE	DIMENSIONS (MM)		
		WIDTH	HEIGHT	DEPTH
BOX ABACUS PRO - INDOOR APPLICATION WITH BLANK DOOR				
APRO6540B	10	600	500	400
APRO6550B	10	600	500	500
APRO6560B	10	600	500	600
APRO6640B	13	600	600	400
APRO6650B	13	600	600	500
APRO6660B	13	600	600	600
APRO6840B	17	600	800	400
APRO6850B	17	600	800	500
APRO6860B	17	600	800	600

Note: Further dimensions available on request.

BOX ABACUS PRO - INDOOR APPLICATION WITH GLAZED DOOR				
APRO6540BV	10	600	500	400
APRO6550BV	10	600	500	500
APRO6560BV	10	600	500	600
APRO6640BV	13	600	600	400
APRO6650BV	13	600	600	500
APRO6660BV	13	600	600	600
APRO6840BV	17	600	800	400
APRO6850BV	17	600	800	500
APRO6860BV	17	600	800	600

Note: Further dimensions available on request.



ABACUS PRO BOX Outdoor application

TECHNICAL FEATURES

Enclosure manufactured from sheet steel, supplied with cable entry and blank reversible door, complete with nr. 2 rack profiles mounted on the front. Enclosure suitable for the assembly of both nr. 2 additional rack profiles on the back and the mounting plate. Rack profiles manufactured from galvanized sheet steel. Rain canopy manufactured from sheet steel.

PAINT FINISH

- Double layer of special powder coating: epoxy polyester resin primer and second polyester layer with anticorrosion pigments.
- Colour: RAL 7035 smooth finish.

SUPPLY

- Enclosure
- Door provided with locking system with Viro key and 2 zincpassivated rails
- Cable entry plate with sealing gasket
- Nr. 2 rack profiles
- Rain canopy
- Screws for earth connection and mounting accessories.



PROTECTION RATING

- IP66 complying with EN60529
- NEMA 4 (single door) complying with NEMA 250
- protection degree guaranteed by the two component foam seal
- impact resistance IK10 complying with EN62262.

CODE	HE	DIMENSIONS (MM)		
		WIDTH	HEIGHT	DEPTH
BOX ABACUS PRO - OUTDOOR APPLICATION WITH BLANK DOOR				
APR06540B0	10	600	500	400
APR06550B0	10	600	500	500
APR06560B0	10	600	500	600
APR06640B0	13	600	600	400
APR06650B0	13	600	600	500
APR06660B0	13	600	600	600
APR06840B0	17	600	800	400
APR06850B0	17	600	800	500
APR06860B0	17	600	800	600

Note: Further dimensions available on request.

ABACUS PRO BOX ACCESSORIES

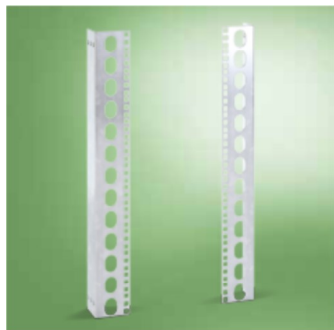

19" PROFILES

RACK PROFILES	
CODE	HEIGHT BOX
AEP0270	500
AEP0271	600
AEP0272	800

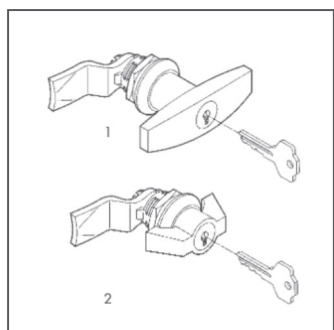

HANDLES

Further to ETA standard locking system, ETA offers a wide range of handles with key-lock insert, pad-locking option, push-button release or special inserts.

LOCKING SYSTEMS	
CODE	DESCRIPTION
WE235	VIRO INSERT WITH KEY
WE285	T HANDLE WITH KEYLOCK
WE288	WING HANDLE WITH KEYLOCK



RAIN CANOPY

Manufactured from sheet steel.

PAINT FINISH

ETA standard epoxy polyester powder coating.
Colour: RAL7035 textured finish.

SUPPLY

Nr. 1 piece with mounting accessories

ROOF CANOPY		
CODE	WIDTH	DEPTH
AEP0300	600	400
AEP0301	600	500
AEP0302	600	600



POLE MOUNTING KIT FPST-001

To fix the box to a pole with round or rectangular section. Rail manufactured from galvanized sheet steel and clamp collar.

SUPPLY

Nr. 2 rails and nr. 2 clamps with mounting accessories.



LOUVERED CABLE ENTRY PLATES

Manufactured from sheet steel.

PAINT FINISH

ETA standard epoxy polyester powder coating.
Colour: RAL7035 textured finish.

SUPPLY

Nr. 1 piece with mounting accessories.

LOUVERED CABLE ENTRY PLATES		
CODE	BOX WIDTH	BOX DEPTH
AEP0280	600	400
AEP0281	600	500
AEP0282	600	600



PUNCHED CABLE ENTRY PLATES

Manufactured from sheet steel.

Colour: RAL7035 textured.

Supply includes nr. 1 piece complete with gasket and mounting accessories for FL frame.

PUNCHED CABLE ENTRY PLATES			
CODE	DIM. PLATE	NR. HOLE	HOLE DIM.
WC016FL	158 x 78	1 for FL13	118 x 30
WC018FL	258 x 78	1 for FL13	118 x 30
WC019FL	258 x 128	1 for FL21	196 x 62
WC020FL	358 x 128	1 for FL21	196 x 62
WC022FL	558 x 128	2 for FL21	196 x 62

FRAMES				
CODE	DESCRIPTION	L1	L2	H
WC2665404	FRAME FL13	134	52	6,5
WC2665400	FRAME FL21	214	90	9

Note: "click&fit" inserts to be ordered separately.
Please contact our Sales Department.

MOUNTING PLATE WPAZ

Manufactured from sendzimir sheet steel sp. 2,5 mm.

MOUNTING PLATE		
CODE	WIDTH	HEIGHT
WPAZ-ST65	600	500
WPAZ-ST66	600	600
WPAZ-ST68	600	800



WALL-MOUNTING BRACKETS SDWC-010

Manufactured from zincapssivated sheet steel sp. 2,5 mm.

Supply include nr. 4 pieces.



MODULAR PLINTH APZE

Modular plinth consisting of corner pieces and side/front crosspieces manufactured from sheet steel.

Paint finish: ETA standard epoxy polyester powder coating.

Colour: RAL9011 textured finish.

Supply includes: corner pieces (4 pieces with PVC front cover caps and mounting accessories), front crosspieces (2 pieces) and side crosspieces (2 pieces).



MODULAR PLINTH		
CODE	DESCRIPTION	DIMENSIONS (MM)
APZE-A100	CORNER PIECES (4PC) H=100	100
APZE-A200	CORNER PIECES (4PC) H=200	200
APZE-T0600	FRONT CROSSPIECES (2PC)	600
APZE-T0400B	SIDE CROSSPIECES (2PC)	400
APZE-T0500B	SIDE CROSSPIECES (2PC)	500
APZE-T0600B	SIDE CROSSPIECES (2PC)	600

Note: To order the plinth H=200, please add D to the code (i.e. APZE-T0600D).

To order the plinth in the ventilated version add S to the code of the front crosspieces (i.e. APZE-T0600S).



PRO

ABACUS PRO SOLUTIONS FOR SPECIAL APPLICATIONS Outdoor

CHARACTERISTICS

The profile used for uprights and crosspieces is unique, manufactured from high-strength low-alloy sheet steel (HSLA), closed with continuous fiber laser welding and free of sharp edges. The bottom is a single piece with box-type structure manufactured from press-bent fiber laser-MIG hybrid welded profiles manufactured from high-strength low-alloy sheet steel (HSLA). The frame corners are manufactured with orthogonal joints laser welded to vertical upright rails and horizontal rails for the roof and bottom. Only 8 high resistance screws are necessary to mount the structure, while two position pins allow the easy mounting of the two parts of the joint.



CABINET ABACUS PRO - OUTDOOR



SUPPLY

- structure manufactured from high-strength low-alloy sheet steel (HSLA) with bottom supplied with adjustable cable entry
- blank reversible door with stiffening frame, complete with \varnothing 3 mm lever-operated locking system with key
- removable roof
- rain canopy
- rear panel and side panels manufactured from sheet steel with rounded folding, specifically designed for intrusion protection
- 19" frontal rails (2pcs).

PAINT FINISH

- Double layer of special powder coating: epoxy polyester resin primer and second polyester layer with anticorrosion pigments.
- Colour:
 - structure: RAL 7035 smooth finish
 - door and rear panel: RAL7035 textured finish
 - roof and rain canopy: RAL9011 textured finish.

PROTECTION RATING

- IP55 complying with EN60529
- NEMA 12 complying with NEMA 250
- protection degree guaranteed by the two-component foam seal
- impact resistance IK10 complying with EN62262.

KIT IP>55

Available on request cabinet with single door (free-standing or joined in a suite) with protection rating higher than IP55.



RAIN CANOPY

It guarantees an additional protection for outdoor applications.

PAINT FINISH

Double layer of special powder coating: epoxy polyester resin primer and second polyester layer with anticorrosion pigments.
Colour: RAL 9011 textured finish.



MONOBLOC SOLUTIONS FOR OUTDOOR APPLICATIONS

CHARACTERISTICS

Monobloc enclosure, roof, door and rear panel manufactured from aluminium alloy AlMg3 or sheet steel.

- welded monobloc structure with removable rear panel (single walled version); welded monobloc structure with removable rear panel and provided with external covers (double walled version)
- rear and side covers fixed to the monobloc structure without the aid of screws, with a pre-defined mounting sequence and a logical system of joint (only for double walled version)
- roof with ventilation slots and screwed to the monobloc enclosure (even hinged for double walled version)
- exclusive frontal access with a door provided with a two-component polyurethane foam seal, 3 points lever-operated locking system and key lock
- 40 mm high rain canopy with a 20 mm overhang on all sides
- removable and screwed cable entry plates
- available with the double door for W=1200 mm
- plinth H=100/200 available with front blank or ventilated crosspieces*.



Thanks to the specific constructive concept, high quality materials and resistant finishes, the range of outdoor solutions E VIS provides the perfect protection of the framework internal components by environmental factors, extreme temperatures, direct sunlight, harsh environment, vandalism and atmospheric, chemical and mechanical agents.

Possibility to design solutions with special dimensions, different finishes, special insulations, silicone seal or completely customised solutions according to customers' requirements.

OUTDOOR CABINET ABACUS PRO - MONOBLOC SOLUTIONS



PAINT FINISH

- Mild steel version: double layer of special powder coating: epoxy polyester resin primer and second polyester layer with anticorrosion pigments (RAL 7035 smooth for the cabinet, Pantone 2717U smooth for roof and plinth)
- Aluminium alloy version: special painting process with a single polyester powder coating with zinc base (RAL7035 smooth for enclosure, Pantone 2717U smooth for roof and plinth).

PROTECTION RATING

- IP56 (single door) and IP55 (double door) complying with IEC EN62208; EN60529
- protection degree guaranteed by the two-component foam seal**
- impact resistance IK 10 complying with IEC EN62208; EN62262.

* Plinth to be ordered separately.

** Solution with two-component silicone foam seal available upon request.

CODE		DIMENSIONS (MM)		
ALUMINIUM ALLOY	MILD STEEL	WIDTH	HEIGHT	DEPTH
OUTDOOR CABINET ABACUS PRO - SINGLE-WALL				
EVIS060804SA	EVIS060804SM	600	800	400
EVIS061204SA	EVIS061204SM	600	1200	400
EVIS061205SA	EVIS061205SM	600	1200	500
EVIS061404SA	EVIS061404SM	600	1400	400
EVIS080804SA	EVIS080804SM	800	800	400
EVIS081204SA	EVIS081204SM	800	1200	400
EVIS081205SA	EVIS081205SM	800	1200	500
EVIS081404SA	EVIS081404SM	800	1400	400
EVIS120804SA	EVIS120804SM	1200	800	400
EVIS121204SA	EVIS121204SM	1200	1200	400
EVIS121205SA	EVIS121205SM	1200	1200	500
EVIS121404SA	EVIS121404SM	1200	1400	400
OUTDOOR CABINET ABACUS PRO - DOUBLE-WALL				
EVIS060804DA	EVIS060804DM	600	800	400
EVIS061204DA	EVIS061204DM	600	1200	400
EVIS061205DA	EVIS061205DM	600	1200	500
EVIS061404DA	EVIS061404DM	600	1400	400
EVIS080804DA	EVIS080804DM	800	800	400
EVIS081204DA	EVIS081204DM	800	1200	400
EVIS081205DA	EVIS081205DM	800	1200	500
EVIS081404DA	EVIS081404DM	800	1400	400
EVIS120804DA	EVIS120804DM	1200	800	400
EVIS121204DA	EVIS121204DM	1200	1200	400
EVIS121205DA	EVIS121205DM	1200	1200	500
EVIS121404DA	EVIS121404DM	1200	1400	400

PRODUCT CODE				DESCRIPTION
ALUMINIUM ALLOY		MILD STEEL		
BLANK	VENTILATED	BLANK	VENTILATED	
OUTDOOR CABINET ABACUS PRO - MODULAR PLINTH				
EVZE-T0400A	EVZE-T0400AV	EVZE-T0400M	EVZE-T0400MV	SIDE CROSSPIECES WITH INTEGRATED CORNERS H=100
EVZE-T0500A	EVZE-T0500AV	EVZE-T0500M	EVZE-T0500MV	SIDE CROSSPIECES WITH INTEGRATED CORNERS H=100
EVZE-T0600A	EVZE-T0600AV	EVZE-T0600M	EVZE-T0600MV	FRONT CROSSPIECES (2PC)
EVZE-T0800A	EVZE-T0800AV	EVZE-T0800M	EVZE-T0800MV	FRONT CROSSPIECES (2PC)
EVZE-T1200A	EVZE-T1200AV	EVZE-T1200M	EVZE-T1200MV	FRONT CROSSPIECES (2PC)



PRO

MONOBLOC SOLUTIONS

A range of monobloc enclosure solutions proposed as the effective combination of strength and modularity.

Offered with a particular front and rear aesthetic profile to guarantee uniformity with ETA design, the enclosure is built up with a unique symmetric monobloc structure with top, bottom and side panels welded, and front door provided with an innovative lever-operated latch system.

Completely compatible with ETA standard range of accessories, it can be completely customized thanks to the assembly of specific vertical uprights, which allow creating the same inner spaces of modular cabinet system: a unique cabinet completely welded, with mounting plate included in the supply and available in 27 standard dimensions.

PROTECTION RATING

- IP66 (single door).
- IP55 (double door).
- Nema 12, IK10.

Note: Rails for rack mounting on W \geq 800 to be ordered separately





PRO

SOUNDPROOF CABINET

The increasing compression of servers and equipment has led to big problems in heat and noise management, especially if the rack is installed in work environments where even the safety regulations are limiting the acoustic noise level itself.

ETA can solve your problem by manufacturing soundproof cabinets based on ABACUS PRO concept - which is already offering a strong protection from noise - and strengthening it with a proper soundproofing kit. If needed, the rack system installed in the cabinet can be also ventilated or cooled by using specific low-noise fans.

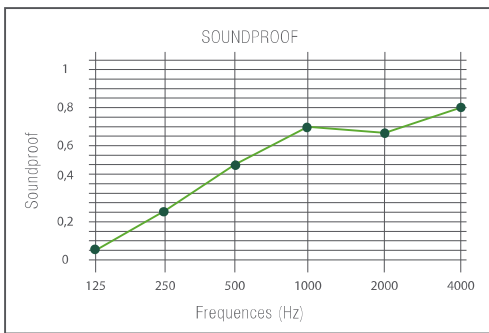



PRO

SEISMIC DESIGN

The seismic design study starts from the vulnerability evaluation of the structure located in different geographical scales. Thanks to the activity developed together with the Foundation Eucentre Pavia, TREES Lab (Laboratory for Training and Research in Earthquake Engineering and Seismology), we have set the following research activities:

1. Modelling and numerical simulation of the seismic response of two cabinets, in order to study, during the design phase, the behaviour that the systems considered (with anti-vibration plinth and anti-seismic kit) would have manifested towards seismic actions in various geographical areas and on different soils.
2. Seismic simulation of the two cabinets dynamic behaviour on a vibrating table, with experimental tests on structures in order to realize experimental research on prototypes, also in large-scale (both static and dynamic tests).



Three solutions are offered:

BASIC

For ABACUS PRO cabinets dim. 800xHx600 and 800xHx800
Peak acceleration $\leq 1G$.
Mounting plate loaded up to 130 kgs.

CHARACTERISTICS

Plinth manufactured from press bent sheet steel, with anti-vibration elements and the possibility of floor fixing.
Nr. 2 rails mounted in depth for the central fixing of the mounting plate.

MEDIUM

For ABACUS PRO cabinets dim. 800xHx600 and 800xHx800
Peak acceleration $\leq 1G$.
Loaded mounting plate > 130 ≤ 450 kgs.

CHARACTERISTICS

Plinth manufactured from press bent sheet steel, with anti-vibration elements and the possibility of floor fixing.
Nr. 2 rails mounted in depth for the central fixing of the mounting plate.
Nr. 2 top and bottom fixing brackets for mounting plate, manufactured of galvanized steel.

STRONG

For ABACUS PRO cabinets dim. 800x2000x600 and 800x2000x800
Peak acceleration > 1G.
Loaded mounting plate ≤ 450 kgs.

CHARACTERISTICS

Plinth manufactured from press bent sheet steel, with anti-vibration elements and the possibility of floor fixing.
Nr. 2 rails mounted in depth for the central fixing of the mounting plate.
Nr. 2 top and bottom fixing brackets for mounting plate, manufactured of galvanized steel.
Nr. 4 stiffening frames manufactured from galvanized steel.
Nr. 8 stiffening structure brackets manufactured from galvanized steel.

ANTI-VIBRATION PLINTH APZV

Manufactured from press-bent sheet steel H=100mm, with special anti vibration devices.
Colour: RAL9011 textured.

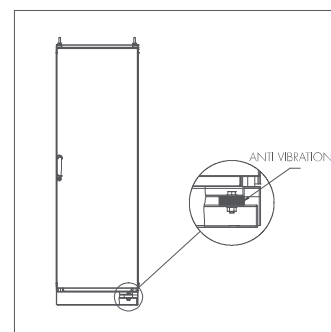



PRO

PC SOLUTIONS

PC enclosures with sliding shelf and pull-out keyboard installed on a modular structure, available in both assembled and flat-pack version with front section to be designed according to specific requirements. The assembled version includes the cabinet structure complete with high-strength low-alloy sheet steel uprights and bottom, roof and rear panel manufactured from sheet steel.

The front section is composed by: plexi upper door for monitor vision, pull-out Keyboard with tilting front, complete with adjustable mouse pad, sealed section to separate keyboard compartment/enclosure and lower blank front door.

The flat-pack version includes a pair of high-strength low-alloy sheet steel front uprights, the roof manufactured from sheet steel and the high-strength low-alloy sheet steel bottom.

The front section can be composed by: upper plexi door for monitor vision, upper screwed blank panel or upper hinged blank door; pull-out Keyboard or blank panel; lower hinged blank door.

PROTECTION RATING

IP55





PRO

EMC SOLUTIONS

The EC Directive 2004/108/CE on electromagnetic compatibility applies to equipment and units that can generate/receive electromagnetic waves and liable to cause interferences, altering the correct functioning of electronic equipment installed in the cabinets. Our products, not being a source of electromagnetic waves, go beyond the dispositions of the Directive, but they can act as a barrier of the electromagnetic waves which propagate from the internal and external source: this allows a significant damping of the electromagnetic field strength (both the electric and the magnetic components of the field) and, as a consequence, of the disturbance that they cause to the equipment.

Cabinets manufactured from high-strength low-alloy galvanized sheet steel (HSLA); door and panels manufactured from sheet steel, galvanized on both sides and painted only externally.

PROTECTION RATING

NEMA 1.





STAINLESS STEEL SOLUTIONS

Ideal solutions for indoor and outdoor applications where it is required a high degree of hygiene and/or resistance to chemical agents and weather conditions: suite cabinets, monobloc cabinets, wall-mounting boxes, terminal boxes, electrical enclosures complying with ATEX, enclosures with sloped roof, pushbutton boxes, suspension arm system and control desks manufactured from AISI304L and AISI316L stainless steel.

New manufacturing concepts and innovative design to grant high levels of performance and great functionality: for example, suite cabinets supplied with orthogonal joints manufactured from AISI316L, door with formed corners and silicone gasket, lever-operated locking system and components manufactured from stainless steel.





PRO

ENCLOSURES COMPLYING WITH ATEX

The ETA wall-mounting enclosures manufactured from AISI304L (AISI316L on request) stainless steel material are in compliance with the European Directive 94/9/CE that aims to ensure the free circulation in the EU countries for the products concerned and it is applied to the equipment and protective systems indeed to be used in potentially explosive atmosphere (ATEX), for the presence of flammable substances in the form of gases, vapours, mists or dusts.

The welded enclosure is supplied with door with formed corners and two-component poliurethane foam seal, stainless steel hinges, external anti-rotation and anti-slip stud M6 welded on the body and mounting plate.

PROTECTION RATING

- IP66
- Nema 4X
- IK10

CLASSIFICATION

- Ex II 2G - Ex e IIC Gb.
- Ex II 2D - Ex tb IIIC Db.





The ongoing evolution of server is leading to an increasing demand of efficiency for data center applications. To design properly a data center requires specified products suitable for that use: rack server with high levels of ventilation, intelligent PDU, monitoring system, cooling system, auto-off systems, divided modules.
Thanks to ETA experience, your project will evolve into an efficient solution.

A B A C U S

SYSTEM

DACE



D A C E

COOLING SOLUTIONS

ETA's cooling modules are designed to meet the increasing cooling requirements of server systems, which are more and more often mounted in high-density racks. In such applications, in order to achieve low energy consumption even with high thermal loads, the new systems are designed to be easily combined with ETA's server cabinets. They are available in two configurations:

- "IN ROW" configuration (front airflow), for hot-cold aisle installations
- "IN RACK" configuration (air recycling), for fully compartmentalized high-density racks

There are also two cooling options:

- Gas cooling: air is cooled by means of a cooling gas blown into the internal units (in-row or in-rack) by external moto-condensing or moto-evaporating units. This solution is typically used in small-medium installations, or when a chilled air circuit is not available, or when the use of water in the proximity of equipment is not allowed.
- Water cooling: in this case, a chiller installed outdoors produces and distributes chilled water to the internal units (in-row or in-rack), adjusting temperature and pressure. This solution is typically used for medium-large or long-distance applications and for high power requirements.





COOLING MODULE			
CODE	CONFIGURATION	COOLING TYPE	KW
AD008RAG	IN RACK	GAS	8
AD015RAG	IN RACK	GAS	15
AD012RAA	IN RACK	WATER	12
AD020RAA	IN RACK	WATER	20
AD025RAA	IN RACK	WATER	25
AD008ROG	IN ROW	GAS	8
AD015ROG	IN ROW	GAS	15
AD012ROA	IN ROW	WATER	12
AD020ROA	IN ROW	WATER	20
AD025ROA	IN ROW	WATER	25

SINGLE SIDE PANEL FOR COOLING MODULE				
CODE	CONFIGURATION	H	D	PANEL TYPE
ADF1100200F	IN RACK	2000	1000	PUNCHED
ADF1120200F	IN RACK	2000	1200	PUNCHED
ADF1100200C	IN ROW	2000	1000	BLANK
ADF1120200C	IN ROW	2000	1200	BLANK

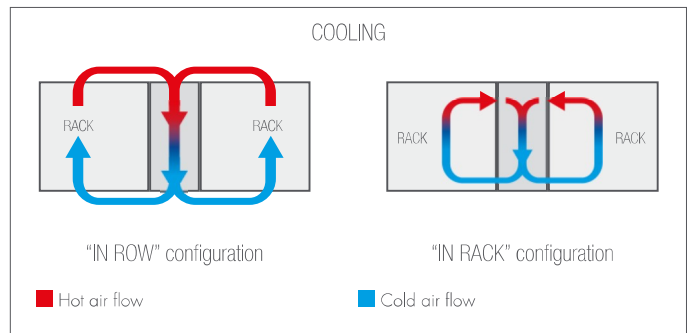



D A C E

POWER SUPPLY

The Power Distribution Units offered by ETA enable the download and the free-of-charge use of a special software that can be used from any web browser: this tool allows the user to link any PDU of your LAN or BAN (local or geographic) and to monitor the critical PDU. Moreover, the software can be integrated with other products (if managed through web browser).

METERED PDU

Supplied with network card and remote monitoring. Calculating the total absorption and the local monitoring through display and via IP through web browser.

METERED PDU			
CODE	OUTPUT	DETAILS	A
AEP0500	16	1-Phase	32
AEP0501	24	1-Phase	32
AEP0502	24	3-Phase	16
AEP0503	24	3-Phase	32

FULL-MANAGED PDU

Supplied with network card, remote monitoring and individual on-off of the single output for reset or server reboot. They can be used to monitor the electrical parameters of each output for each equipment. Calculating the total absorption and the local monitoring through display and via IP through web browser.

FULL-MANAGED PDU				
CODE	OUTPUT		DETAILS	A
	C13	C19		
AEP0512	18	6	3-Phase	32



SWITCHED PDU

Supplied with network card, remote monitoring and individual on-off of the single output for reset or server reboot.
Calculating the total absorption and the local monitoring through display and via IP through web browser.

SWITCHED PDU					
CODE	OUTPUT		DETAILS	A	"T" SENSOR AVAILABLE
	C13	C19			
AEP0504	8	---	19"	16	NO
AEP0505	14	2	1-Phase	16	NO
AEP0506	14	2	1-Phase	32	YES
AEP0507	21	3	1-Phase	16	YES
AEP0508	21	3	1-Phase	32	YES
AEP0509	21	3	3-Phase	16	YES
AEP0510	18	6	3-Phase	32	YES

Note: for some items, T sensor available on request (AEP0511).



CONSOLE KVM

CONSOLE KVM 17" – AEP0400

A smart and compact IT solution for accessing your rack based computers. The unit is housed in a rack mountable, sliding 1U drawer that can fit into any standard sized rack, making it perfect for situations where space is at a premium. In addition to a 17" LCD folding monitor, the station includes a keyboard with a separate numeric keypad, and a touchpad mouse. The folding and sliding features provide for easy and quick station access when needed, while preventing the keyboard and screen from blocking access to other rack equipment when the console is not in use. It can display video from VGA sources. Keyboard and mouse is standard PS2/USB. The connectors on the back of the unit are 3 in 1xVGA, PS2/USB.

SUPPLY INCLUDES

- Console (cable included)
- Various mounting slides for any 1U (19") Rack (800-1000mm)
- Integrated Teleskope-Rails
- Lockable Front panel
- RGB analog LCD Display up to 1280x1024 with 300 cd/m² brightness (17"), full HD 1920x1080
- Flexible External Mouse.

CHARACTERISTICS

- Heavy-duty Steel
- Case color RAL 9005 (optional RAL 7035)
- 106 Key Windows PS/2 or USB Keyboard with Touchpad
- Monitor open angle 0° - 105°
- Connection 1xCombo connector HD15, 1xVGA, 2x PS2 or USB for Keyboard and Touchpad. Full HD: VGA, DVI USBx2
- Touchpad Keyboard Layouts: German /US-English / French / Italian / Spanish (further Layouts on request).



KVM SWITCH

A smart and compact IT solution for accessing your rack based computers. The unit is housed in a rack mountable, sliding 1U drawer that can fit into any standard sized rack, making it perfect for situations where space is at a premium. In addition to a 17" LCD folding monitor, the station includes a keyboard with a separate numeric keypad, and a touchpad mouse. The folding and sliding features provide for easy and quick station access when needed, while preventing the keyboard and screen from blocking access to other rack equipment when the console is not in use. It can display video from VGA sources. Keyboard and mouse can be either standard USB or PS/2. The connectors on the back of the unit are HD15 3-way combo with VGA, PS/2, or USB. The unit comes standard with a VGA and PS/2 cable.

SUPPLY INCLUDES

- Console with switch (8 or 16 modules)
- Various mounting slides for any 1U (19") Rack (800-1000mm)
- Integrated Telescope-Rails
- Lockable Front panel

- RGB analog LCD Display up to 1280x1024 with 300 cd/m² brightness (17"). Full HD 1920x1080
- LED backlight
- Extended power supply 100V~240VAC, 50~60Hz

CHARACTERISTICS

- Heavy-duty Steel
- Case color RAL 9005 (optional RAL 7035)
- 106 Key Windows PS/2 or USB Keyboard with Touchpad
- Monitor open angle 0° - 105°
- AEP0401: 8xHD15 Combo 3 in 1 for VGA/ PS2 or USB
- AEP0402: 16xHD15 Combo 3 in 1 for VGA/ PS2 or USB
- Touchpad Keyboard Layouts: German /US-English / French / Italian / Spanish (further layouts on request)



Notes: Cable and PS2 to be ordered separately.
On request: KVM D=430mm to be installed in cabinets D=600mm – AEP0404



DACE

KVM SWITCH STAND-ALONE

KVM SWITCH STAND-ALONE

- 1U design for any standard 19" Rack
- Front panel out of brushed Aluminium or Black 9005
- Multi-Bank able / control up to 256 Computers from only one Console
- Resolution up to 1920x1440 for high Video quality

STAND-ALONE KVM SWITCH			
CODE	OUTPUT		CONNECTORS ON THE BACK SIDE
AEP0405	8	128 (with 16 modules)	8xDB-15 (PS/2 / USB + VGA) for PC - 1xVGA and 2xPS/2 for consolle
AEP0406	16	256 (with 16 modules)	16xDB-15 (PS/2 / USB + VGA) for PC - 1xVGA and 2xPS/2 for consolle

EXTENDER

The Single Access KVM Extender Kit is perfect for any type of installation where the console needs to be in a conveniently accessible location, but the computer system to reside in a long distance place away from dust, and harsh environmental influences. It extends PC KVM (Keyboard, Video, and Mouse) control to the Console Receiver. The CAT5 or higher cable connects to the Transmitter and Receiver Units - up to 300M (1000 ft.) apart. Single Console operation - control your PC from Console Receiver USB keyboard, mouse and VGA monitor.

FEATURES

- High resolution video up to 1920 x 1200 @ 60 Hz.
- Supports VGA, DVI, HDMI and Multisync Monitors
- Console Receiver has video Gain and EQ adjustments for optimum image.
- RGB skew adjustment
- Pure hardware, Plug n Play design
- USB 2.0 options, audio. RS232.





Website, E Magazine, catalogues: stay in touch with ETA world!

Do you need further support? We can provide you with drawings, technical sheets, E Book, certifications, declarations of conformity.



Flexibility and customisation for your special projects.



A team of reliable people for each step of the process.



Pre and after-sales assistance.



TECHNICAL SECTION

TECHNICAL SECTION















DEGREE OF PROTECTION IP (EN60529)

Protection against direct contact with live parts of the assembly must be guaranteed. The enclosure is designed to ensure protection of equipment against specific external influences and protection in all directions from direct contact, with a protection rating of at least IP2X. Protection against indirect contacts (i.e. protection against faults) is achieved using insulation. The enclosure manufacturer guarantees the protection rating of its product as sold, i.e. empty. The assembly manufacturer is responsible for the definition of the protection rating of the complete and finished assembly (through testing or through design verification analysis). Where an empty enclosure in accordance with EN62208 is used, and no external modification has been made that may result in deterioration of the protection rating, no further testing is required.

Note: the openings made for cable entries and/or for installing the devices, may lower the protection rating; therefore, it is important that the holes are made according to best practices and that seals are used to ensure, by the manufacturer,

that the initial conditions are maintained, where possible. If this is not possible, the protection rating of the enclosure must be downgraded (it cannot be less than IP2X). It is important to keep in mind that the higher the protection rating, the greater the reduction in value of natural power dissipation from the enclosure (see paragraph).

The degree of protection IP is essentially defined by two characteristic numerals (EN60529):

IP 1ST DIGIT = SOLID		IP 2ND DIGIT = LIQUID/GAS	
0	 No protection	0	 No protection
1	 Protection against solid bodies above 50 mm (E.G. Involuntary hand contact)	1	 Protection against vertically falling water drowps
2	 Protection against solid bodies above 12 mm (e.G. Finger)	2	 Protection against water drops falling with up to 15° inclination
3	 Protection against solid bodies above 2.5 mm (tools, wires)	3	 Protection against water splashes from all directions
4	 Protection against solid bodies above 1 mm (thin tools, thin threads)	4	 Protection against water splashes from all directions
5	 Protection against dust (no noxious deposits)	5	 Protection against jets of water from all directions
6	 Total tightness to dust	6	 Protection against water splashes similar to sea waves
		7	 Protection against immersion
		8	 Protection against submersion

IP SEALS

Generally, the enclosure has a seal applied around the perimeter of all closing panels (doors, side panels, rear panels, covers).

POLYURETHANE SEAL

HF1 fire resistance (as per standard UL94).

Optimal environmental conditions for use: temperature: $-40^{\circ}\text{C} < T < 100^{\circ}\text{C}$.

EMC GASKETS

Made of 3 parts: an EPDM core (ensuring the protection rating), a metal fabric coating (that ensures dielectric continuity between the structure and panels) and non-woven double-sided tape, very tough and applied on one side (ensuring adherence and resistance).

Optimal environmental conditions for use: temperature: $-40^{\circ}\text{C} < T < 100^{\circ}\text{C}$.

SILICONE GASKET

Used on the new ranges of stainless steel ETA products, it is resistant to most detergents, hot water jets and is easy to clean.

Optimal environmental conditions for use: temperature: $-50^{\circ}\text{C} < T < 200^{\circ}\text{C}$.

IK RATING (ACCORDING TO EN62202)

Indicates the level of protection provided by the enclosure to the equipment against harmful external mechanical impacts (including vandalism). The test is carried out by applying impact energy, as outlined below: after the test, there must be no failure or deformation likely to compromise the IP rating.

ALL ETA PRODUCTS ARE MARKED WITH THE MAXIMUM RATING IK10 = MAXIMUM RESISTANCE CORRESPONDING TO THE IMPACT OF A 5 KG OBJECT THROWN FROM A DISTANCE OF 40 CM.

CODE IK	IK00	IK01	IK02	IK03	IK04	IK05	IK06	IK07	IK08	IK09	IK10
Impact energy Joule	0,00	0,14	0,2	0,35	0,5	0,7	1	2	5	10	20

NEMA (TYPE)

For Canada and America, the protection degree is defined as NEMA or TYPE and it also indicates the type of use (indoor and outdoor), not only protection from solids and liquids.

NEMA TYPE		NEMA National Electric Manufacturers Association (NEMA 250) and EEMAC Electrical and Electronic Manufacturers Association of Canada UL (standard UL508a) Underwriters Laboratories, Inc.
4	Indoor and outdoor use	Protection against rain, snow and wind-blown dust, sprayed and direct water, and damage due to external icing
12	Indoor use	Protection against dust, falling dirt and non-corrosive dripping fluids.
3R	Outdoor use	Protection against heavy rain and light snow. It prevents ice formation on the inside.
4X	Indoor and outdoor use	Protection against corrosion, wind-blown dust, rain, water sprays and water jets from hoses. It prevents ice formation on the inside.

OVERTEMPERATURE AND CONDENSATION (DUE TO EXPOSURE TO LOW TEMPERATURES)

In environments where the walls reach, on their inner surface, temperatures below the dew point temperature of ambient air, the phenomenon of surface condensation occurs, resulting in the accumulation, on the surfaces of the walls, of a quantity of water that cannot be contained in the air in the form of vapour. Surface condensation is closely related to the internal surface temperature of the wall and therefore depends on, not only the temperature and relative humidity of the ambient air, but also the amount of insulation offered by the wall itself. Generally, surface condensation is closely related to the degree of thermal insulation provided by the wall, since, for an ambient with given thermo-hygrometric characteristics (air temperature and humidity), condensation depends on the temperature where the internal face of the wall is located.

To prevent surface condensation phenomenon, one only needs to keep the internal temperature of the walls above the dew point temperature of ambient air, and therefore check that: $t_{pi} > tR$

The value of dew point temperature tR can be obtained from the Mollier diagram for moist air (where the ambient air temperature and its relative humidity are known), while to calculate the surface temperature it is necessary to estimate the heat balance of the wall (refer to Software QuadroPlan).

Note: if the maximum surface temperature is insufficient to prevent condensation, an anti-condensation space heater can be used to maintain the indoor air – and therefore the surface air – at the desired temperature. To size the heater, the cabinet (or enclosure) open surface must be determined on the X-axis, the intersection point on the T oblique line indicates the necessary thermal power on Y-axis.

Adding appropriate thicknesses of insulation materials helps to prevent surface condensation phenomenon because insulation raises the surface temperature of the wall to above the dew point temperature.

Formula:

$$P = K \times S \times \Delta T$$

where:

P = dissipated thermal power [Watt]

K = heat dissipation coefficient for the enclosure material (for painted sheet steel $K=5.5$ [$W/m^2 \cdot ^\circ C$])

S = open cabinet surface [m^2]

$\Delta T = (T_i - T_e)$

T_i = desired internal temperature

T_e = external temperature [$^\circ C$].

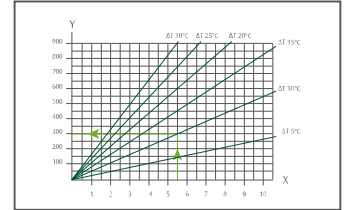
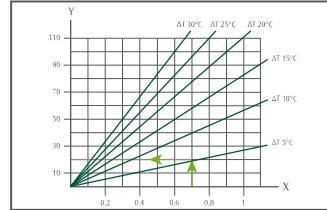

FAN SIZING

The diagram shows how to choose the ventilation units. Select the heat to be dissipated on the Y axis, the intersection point obtained on the required T line gives the necessary air flow on the X-axis.

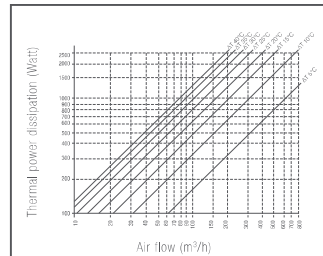

Example:

$P=500$ Watt, $\Delta T=20^\circ C$, $V=80$ m^3/h

A WI 205 fan with $V = 97$ m^3/h is required

Formula

$$V = 3.1 P$$

Where:

V = air flow m^3/h

P = dissipated power Watt

T = $(T_i - T_e)$

T_e = external temperature $^\circ C$

T_i = temperature requested inside the cabinet $^\circ C$

SURFACE TREATMENTS

For INDOOR applications (generally in environments classified as C1, C2 according to EN12944), it is advisable to choose standard dust and standard cycle as the dust is resistant to mineral oils, lubricants, emulsions and cleaning products with low acid content and diluted in concentrations of less than 5%. In presence of particularly harsh chemical substances, the E.T.A. technical staff is available to evaluate the possibility of an ad hoc solution.

For OUTDOOR applications (generally in environments classified as C3), environmental factors (ice, snow, rain, sun, wind, humidity) need to be considered in order to select an assembly with an appropriate IP protection rating (installing a protective roof, if necessary). Polyester powders are recommended for products installed outdoors, because they are very resistant to UV rays. In average corrosion and humidity conditions, anticorrosive zinc-based powder is a valid solution.

For environment with high salinity and high levels of pollution (generally areas in the C4 category: industrial areas and coastal areas, or C5: chemical petrochemical industries, marine environments, offshore), we recommend using zinc plated steel coated with special powders for outdoor use or polished stainless steel and, if necessary, painted. For INDOOR and OUTDOOR applications (food, chemical, petrochemical industries) requiring a high degree of hygiene and/or resistance to chemical and environmental agents, ETA recommends its AISI 304L and AISI 316L stainless steel products.

Stainless steel materials are alloys of iron, chrome and carbon, enriched with other elements such as nickel, molybdenum, silicon, titanium, etc. They stand out for their high resistance to corrosive attacks from external factors. This characteristic is determined by the spontaneous formation of a thin layer of chromium oxide on the stainless steel surface, which protects the metal below from corrosive attacks and from the presence of other elements, such as nickel, molybdenum, titanium, etc. This layer, very stable and tough, prevents direct contact between the surrounding atmosphere and the steel. Unlike conventional protection coatings (zinc-plating, painting, etc.) it has the capacity to restore

itself after accidental breaks, making the material intrinsically resistant to corrosion. There are different degrees of stainlessness or, in other words, a scale of nobility, determined by the chemical composition. The steel selected by ETA is austenitic AISI 304L and 316L, where the L stands for low carbon, which makes the steel even more resistant to corrosion. The presence of elements such as Chrome Nickel and Molybdenum improve the intrinsic characteristics of stainless steel.

The durability of the product subject to salt spray and condensation atmosphere testing depends on:

- sheet type
- production process
- wash cycle
- painting
- powder used

Ageing depends on the different environmental conditions that the installed product is subject to.

Quality: 100% visual inspections.

Periodical E.T.A. in-house laboratory tests of the process on painted samples:

- visual inspection of the surfaces
- thickness testing
- adhesion testing (ISO 2409)
- film adherence test: piercing and bending
- salt spray test as per ISO 9227
- resistance to humidity test as per ISO 6270



E BOOK available for download in ETA Reserved Area www.eta.it



PRODUCT CERTIFICATIONS

LIST OF TRADEMARKS																	
ETA SUITE CABINET	IP55 IK10	NEMA 1,12	zone 1,2,21,22 II2GDc tx	●		●	●	●	●	●		●	●				
ETA WALL-MOUNTING BOX	IP66 IK10	NEMA * 1,12,4,4x	zone 1,2,21,22 II2GDc tx	●		●	●	●	●	●		●	●				
ETA ATEX ENCLOSURE	IP66 IK10	NEMA 1,12,4,4x	zone 1,2,21,22 II2GD eIIcGb tbIIcDb	●		●	●	●	●	●	●	●	●				
ETA MONOBLOC CABINET	IP66 (1 door) IP55 / IK10	NEMA 1,12	zone 1,2,21,22 II2GDc tx	●		●	●	●	●	●		●	●				
ETA OUTDOOR CABINET E VIS	IP56 (1 door) IP55 / IK10					●		●				●	●				
ETA PC CABINET	IP55							●				●	●				
ETA EMC CABINET	IK10	NEMA 1		●				●				●	●				
WT	IP54	NEMA 1,3R,12			●			●				●	●				
* Nema 4x only for Stainless steel wall-mounting box with single blank door Nema 1,12 for double door/plexi door																	
				Usa Canada		Germany		Italy		Europa World			Italy/World		Italy		
				UL International		TUV Rheinland				CE	Atex	EAC	IMQ			Istituto italiano di saldatura	
				UL508A UL50 C22.2 n° 14-95 e CAN/CSA-C22.2 N°94 - M91		IEC EN62208		Naval Certification		IEC EN62208	Potentially Explosive Atmospheres (ATEX)	EurAseC (ex-Gost) - CU TR 004/2011 on safety of low voltage equipment	ISO EN80079-34 ISO EN60079-0 ISO EN60079-7 ISO EN60079-31	UNI EN ISO9001		UNIEN ISO15614-1 cert.n. LB0017/10	



innovative
enclosure solutions
for industrial & electronic
applications

E.T.A. S.P.A.

22035 Canzo - Como (Italy)
Via Monte Barzaghino, 6
t. +39 031.673.611
f. +39 031.670.525
www.eta.it
infosede@eta.it

ETA ENCLOSURES (UK) LIMITED

Unit 2, Ignite,
Magna Way
Rotherham S60 1FD
t. +44 (0) 1709 386630
f. +44 (0) 1709 369524
www.eta-enclosures.co.uk
info@eta-enclosures.co.uk



SASU E.T.A. FRANCE

Rue du Pré aux Boeufs BP455
76806 St Etienne du Rouvray
t. +33 02 35643470
f. +33 02 35642275
www.eta-france.fr
eta-france@wanadoo.fr

E.T.A. S.P.A.

Gagarinskaya st., 12
191187, Saint-Peterburg (Russia) www.eta.it

Technical features of the products
can be changed at any time without notice.
ETA reserves the right to modify
them in order to improve its product offering.

Concept
Zappa Associati

© E.T.A. S.P.A. November 2015

